

MERiH®

LIFT YOUR
EXPECTATIONS

20
21

ÜRÜN KATALOĐU
PRODUCT CATALOGUE



www.merhasansor.com

*Since 1977
where elevator is ...*

Değerli Meslektaşlarım,

Sürekli gelişen ve değişen bir dünyada yaşıyor, üretmeye ve katma değer sağlamaya çalışıyoruz.

Merih ailesi olarak sektörümüzdeki yenilik ve ihtiyaçları takip edip ürün ve hizmet akışımızı doğru yönde ilerletmek gayesi içerisindeyiz. Siz değerli dostlarımıza kaliteli ürün ve hizmet sunabilmek adına hem Ar-Ge hem de ürün yatırımlarımıza hız kesmeden devam ediyoruz. Üretimin yanı sıra sektör içerisinde nitelikli teknik adamların var olması için mesleki eğitime önem veriyor, bu alanda meslek liseleri ve üniversiteler ile iş birliği içerisinde çalışıyoruz.

2018 yılında kurulan Merih Akademi ile sektörümüze nitelikli teknik adamlar yetiştirilmesine katkıda bulduk.

Biliyoruz ki kaliteli ürün üretmek, kaliteli hizmet üretmekle eş zamanlı ilerlemeli ve memnuniyet oluşturabilmelidir. Bizde uzman yönetim ve üretim ekibimiz ile birlikte ortak yaşamı paylaştığımız alanların, yaşamayı arzu ettiğimiz hayatların ve geleceğimizin daha güvenilir olması için çok çalışıyoruz.

Ne mutlu ki 40 yılı aşkın süredir sektör içerisinde yeniliklere öncülük eden çalışmalarımızla Türkiye'de örnek alınan, öncü kurum olmayı başardık. 1977 yılından bugüne dek yaptığımız gibi, zamanın ruhunu doğru okuyarak, teknolojik gelişmeleri takip ederek, hızla, cesaretle ve kararlılıkla çalışmalarımıza devam ediyoruz.

Merih olarak modern kentlerin ihtiyaç duyduğu teknolojik altyapıyla, yenilikçi uygulamalarımızla, kalite odaklı ve uluslararası standartlardaki ürünlerimizle birlikte sizi hep daha yükseğe çıkarmaya devam edeceğiz.

Sevgi ve saygılarımla,

Yusuf ATİK

Dear Colleagues,

Today, we try to make production and add value to our products in a world that constantly develops and changes.

As Merih family, we follow innovations and requirements of our sector and we always do our best to respond to the market demands and provide best commodities and services possible. We continue making our investments in both R&D and our products in order to provide quality commodities and services for you, our dear friends. We give high importance to vocational education because we know that qualified employees are the basis of strong production in our sector. We also strongly cooperate with vocational high-schools and universities in this field.

We contributed to the training of qualified technical staff for our sector by establishing Merih Academy in 2018.

It is a universal truth that in order to manufacture quality product one must also provide quality service and build customer satisfaction altogether. Our management and production teams work hard to ensure safer future and better lives.

It is great that we succeeded to become leading exemplary institution in Turkish elevator sector with our innovative working methods in 40 years since our foundation. We continue our works with courage and determination by following latest technological developments and market's latest demands since 1977.

As Merih we will continue to raise you, our clients, with our technological applications and quality oriented products that comply with international standards.

Kind regards,

Yusuf ATİK



YUSUF ATİK

Yönetim Kurulu Başkanı
Chairman



Merih 1 Fabrika | Merih 1 Factory



Merih 2 Fabrika | Merih 2 Factory



Merih 1 Üretim Sahası | Merih 1 Production Area



Merih 1 Sevkiyat Alanı | Merih 1 Dispatch Area

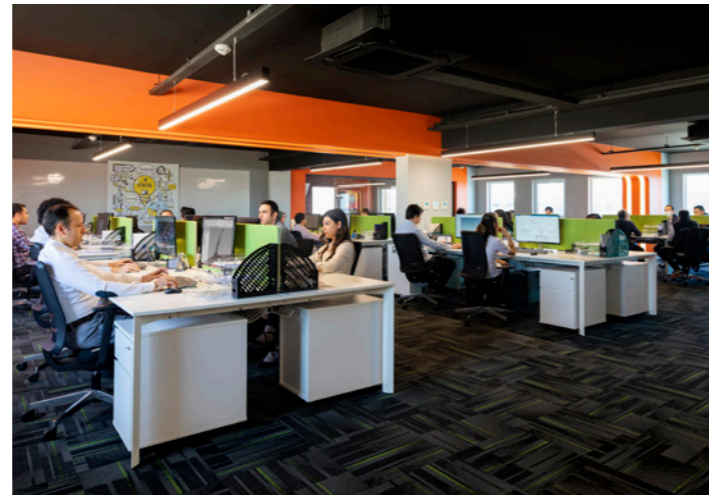

AR&GE Merkezi | R&D Center

1977 yılında kurulan Merih, 40 yılı aşkın tecrübesi ile otomatik kapı, kabin ve komple asansör sistemleri üretimiyle asansör sektörüne hizmet eden öncü bir firmadır. Modern kentlerin ve dikey yapıların asansör ihtiyacını karşılamak için yeni teknolojilerin ışığında sürekli gelişmeyi hedefleyen Merih Asansör, kaliteden ödün vermeyen üretim anlayışı ile müşteri memnuniyetini ilke edinmiştir. Merih uzman üretim, yönetim ve satış ekibinin yanı sıra AR-GE Merkezi ile de uluslararası güncel standartlara uygun yenilikçi projeler üretmekte, sektörüne yön vermektedir.

Merih; 30,000 m² üretim sahasında yıllık 100,000 adet otomatik kapı ve 5,000 adet kabin, kuyu içi aksam üretim kapasitesi, makine motor, kumanda panosu gibi diğer bileşenlerin de imalatı ve Mars marka komple asansör sistemleriyle tüm dünyada öncü bir marka olma yolunda ilerlemektedir.

Merih, 1977 yılında çıktığı yolculukta bugün %100 milli sermayesi ile ulusal ve uluslararası pazarda en önemli asansör markaları arasında yer almaktadır. Tamamen Türkiye'de üretilen ürünleri %100 yerli malı güvencesiyle ve yüksek kalitede piyasaya sunmaktadır. Bugün 65 ülkeye ihracat yaparak, Türk imalat sanayinin gücünü kendi sektöründe en iyi şekilde temsil etmektedir.

Merih nitelikli insan kaynağı, güçlü alt yapısı, vizyonel bakış açısı ve yatırımları, çözüm odaklı yaklaşımı ile satışının her aşamasında ve sonrasında müşterilerinin her zaman yanındadır.

Merih was founded in 1977 and has been a leading producer of automatic door, cabin and complete elevator systems with more than 40 years of experience. With the integration of the latest technology, Merih aims to fulfill the requirements of modern cities and vertical buildings while adopting customer satisfaction as a principle. Alongside Merih Elevator's expert production, administrative and sales team, the R&D Center produces innovative projects according to EN 81-20/50 and 81-58 international standards.

Within its 30,000 m² production facility, Merih has the capacity to produce 100,000 pieces of automatic doors and 5,000 cabins, shaft equipment, machine motor, control panel, and other productions while proceeding the Mars branded complete elevator systems to be a pioneer in the world.

Merih, starting from 1977, it is still one of the most substantial elevator company both in the domestic and foreign market while being a 100% national company. Producing the highest quality of products that are manufactured in Turkey with 100% domestic good standards. Today, exporting to more than 65 countries, Merih exemplarily represents the Turkish production industry in its own sector.

Merih stands beside its customers with qualified human resources, strong infrastructure, visionary perspective and solution-oriented attitude for every step of sales and after-sales procedures.



SERVİS ASANSÖRÜ DUMBWAITER	48
P.A.C KABİNLER İÇİN HAVA TEMİZLEME ÜNİTESİ PURIFYING AIR FOR CABINS	50
OPSİYONLAR OPTIONS	52
SERTİFİKALAR CERTIFICATES	58

MULTICAR

KABİN KAPILARI | CAR DOOR

TEK KUYUDA ÇOKLU KONFIGÜRASYON | MULTI CONFIGURATION IN ONE SHAFT

2 PANEL TELESKOPIK | 2 PANEL TELESCOPIC

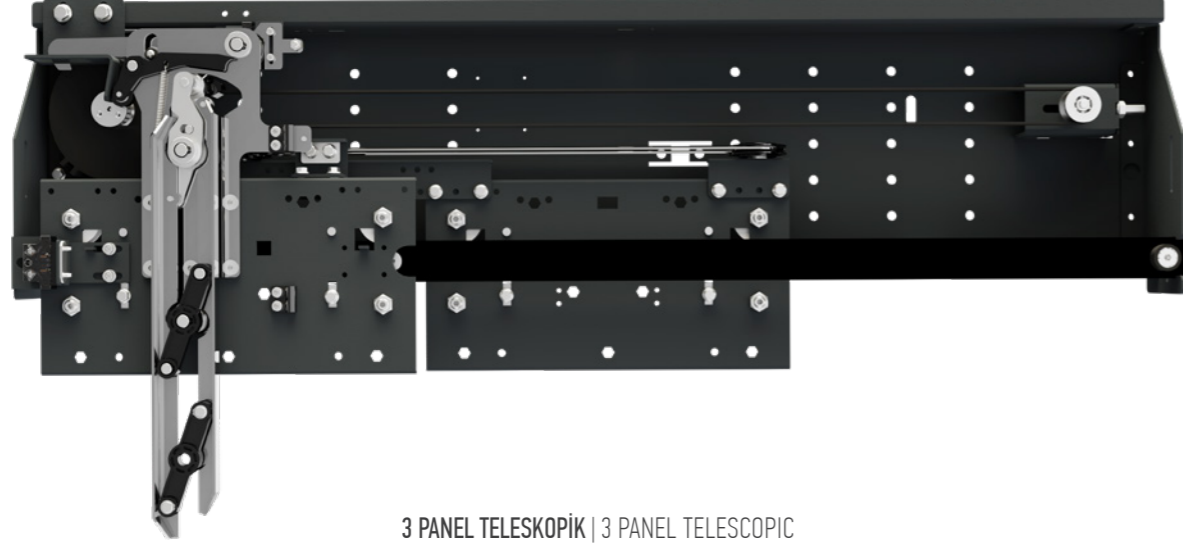

3 PANEL TELESKOPIK | 3 PANEL TELESCOPIC

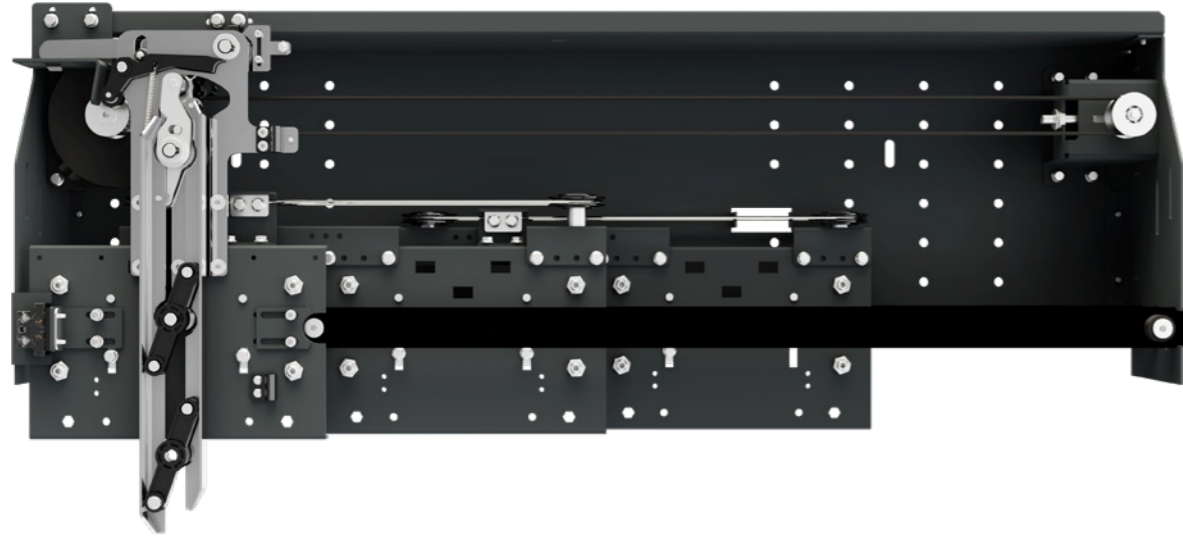

MULTICAR

KABİN KAPILARI | CAR DOOR

TEK KUYUDA ÇOKLU KONFIGÜRASYON | MULTI CONFIGURATION IN ONE SHAFT

2 PANEL MERKEZİ | 2 PANEL CENTRAL

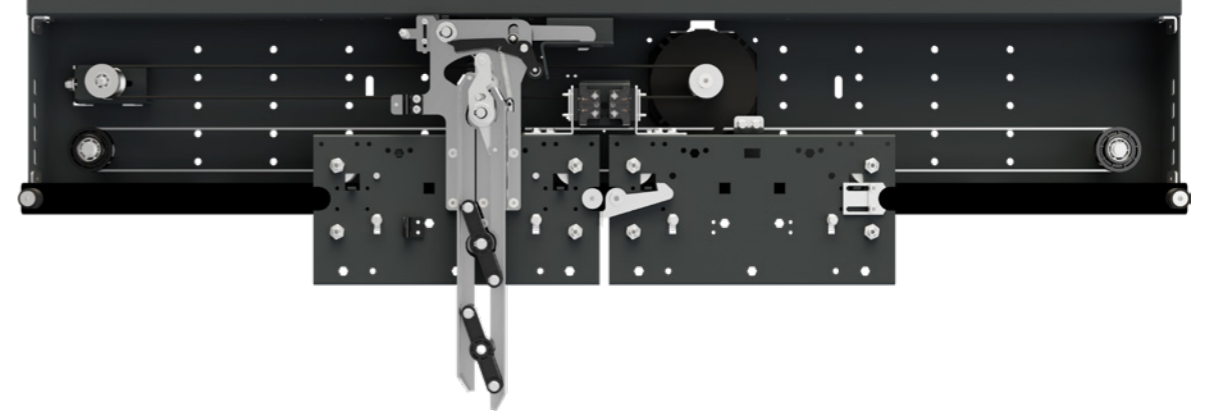

4 PANEL MERKEZİ | 4 PANEL CENTRAL

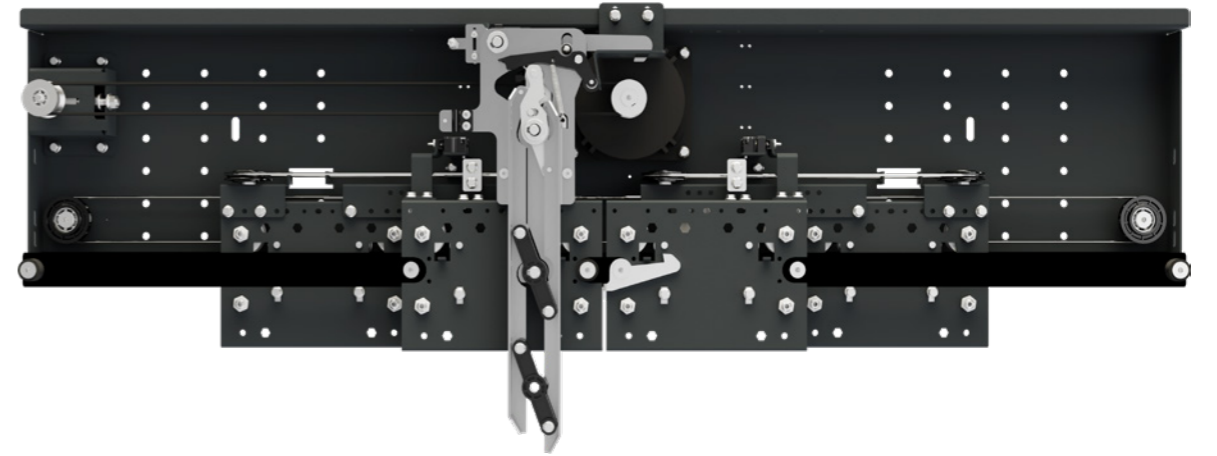

TEKNİK ÖZELLİKLERİ

- Sabit mıknatıslı senkron motor (PMSM)
- VVVF kapı kontrol kartı
- Kablosuz bağlantı ile kapı parametrelerine erişim (Wifi Remote Control)
- Farklı kapı modelleri ile entegre çalışabilme (B01, C01 ve E01)

TECHNICAL SPECIFICATIONS

- Gearless Permanent Magnet Synchronous Motor (PMSM)
- VVVF Direct Door Driver
- Access to Door Operational Parameters with Wireless Connection (Wifi Remote Control)
- Ability to Operate in Synch with Different Landing Door Models (B01, C01 and E01)

EN 81-20 / 50 | CE

MERİH

STANDART ÖZELLİKLER STANDARD FEATURES						
KAPI TİPİ DOOR TYPE	ÇİZİM DRAWING	KAPI GENİŞLİĞİ (min) DOOR WIDTH	KAPI GENİŞLİĞİ (max) DOOR WIDTH	STANDART NET GİRİŞ YÜKSEKLİĞİ STANDART CLEAR HEIGHT	MAKSİMUM NET GİRİŞ YÜKSEKLİĞİ MAX. CLEAR HEIGHT	YÜZEY İŞLEMLERİ SURFACE FINISHING
M2P		700 mm	1300 mm	2000 mm	2300 mm	Ral Renkleri Ral Colors Paslanmazlar Stainless Cam Seçenekleri Glass Options
M4P		900 mm	1300 mm	2000 mm	2300 mm	Ral Renkleri Ral Colors Paslanmazlar Stainless
T2P		700 mm	1300 mm	2000 mm	2300 mm	Ral Renkleri Ral Colors Paslanmazlar Stainless Cam Seçenekleri Glass Options
T3P		700 mm	1300 mm	2000 mm	2300 mm	Ral Renkleri Ral Colors Paslanmazlar Stainless

Ürünlerimiz hakkında daha detaylı bilgi almak için www.merhasansor.com adresini ziyaret ediniz.
In order to more detailed information about our products, please visit www.merhasansor.com

MERİH

B-01

KAT KAPILARI

LANDING DOOR

“Yüksek hızlı ve yüksek trafikli asansör sistemlerinin kullanıldığı her türlü mimari yapılar için estetik ve güçlü tercih...”
“Esthetics and strong choice for high velocity and high traffic elevator systems...”



EN 81-58 | EN 81-20 / 50 | EN 81-72 | CE | EAC

MERİH

B-01

KAT KAPILARI

LANDING DOOR

2 PANEL TELESKOPIK | 2 PANEL TELESCOPIC

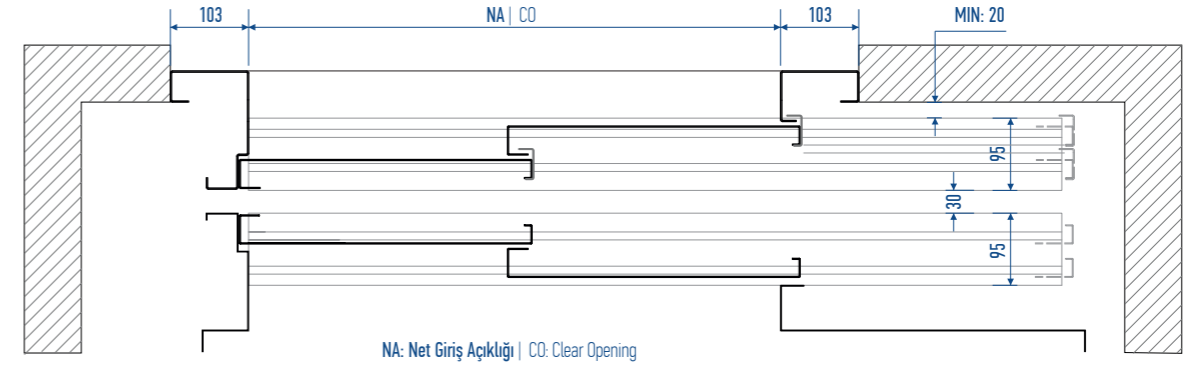

NA: Net Giriş Açıklığı | CO: Clear Opening

2 PANEL MERKEZİ | 2 PANEL CENTRAL

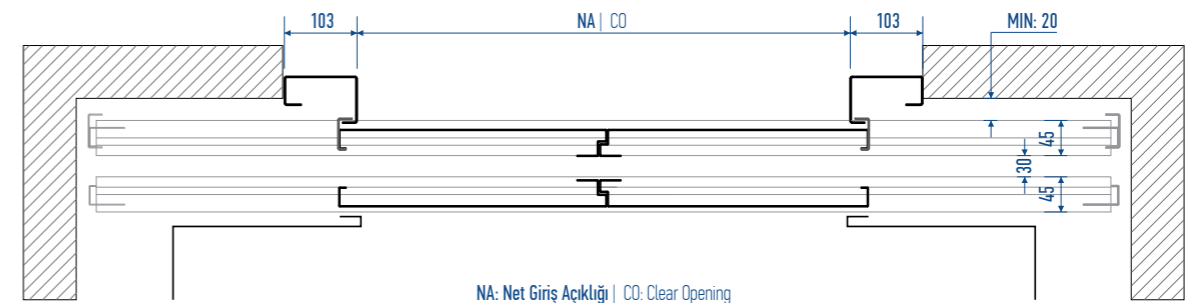
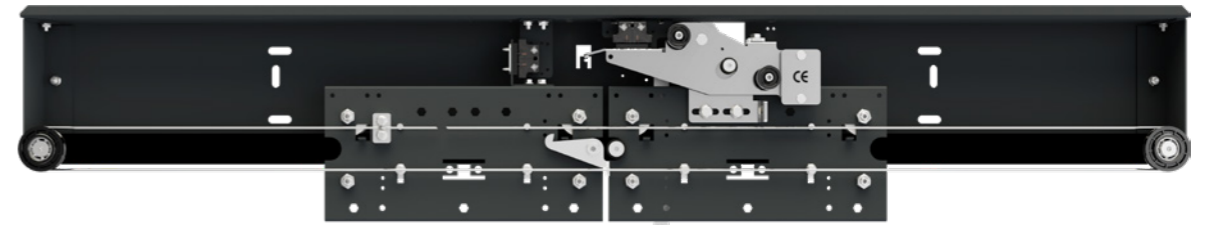

NA: Net Giriş Açıklığı | CO: Clear Opening

STANDART ÖZELLİKLER | STANDARD FEATURES

KAPI TİPİ DOOR TYPE	ÇİZİM DRAWING	KAPI GENİŞLİĞİ (min) DOOR WIDTH	KAPI GENİŞLİĞİ (max) DOOR WIDTH	STANDART NET GİRİŞ YÜKSEKLİĞİ STANDART CLEAR HEIGHT	MAKSİMUM NET GİRİŞ YÜKSEKLİĞİ MAX. CLEAR HEIGHT	Sızdırmazlık Sınıfı Resistant Class			YÜZEY İŞLEMLERİ SURFACE FINISHING
						E	EI	EW	
T2P		700 mm	1300 mm	2000 mm	2300 mm	120	60	60	Ral Renkleri Ral Colors Paslanmazlar Stainless Cam Seçenekleri Glass Options
M2P		700 mm	1300 mm	2000 mm	2300 mm	120	60	60	Ral Renkleri Ral Colors Paslanmazlar Stainless Cam Seçenekleri Glass Options

Ürünlerimiz hakkında daha detaylı bilgi almak için www.merhasansor.com adresini ziyaret ediniz.
In order to more detailed information about our products, please visit www.merhasansor.com

MERİH

B-01

KAT KAPILARI
LANDING DOOR

“Yüksek hızlı ve yüksek trafikli asansör sistemlerinin kullanıldığı her türlü mimari yapılar için estetik ve güçlü tercih...”
“Esthetics and strong choice for high velocity and high traffic elevator systems...”



EN 81-58 | EN 81-20 / 50 | CE | EAC

MERİH

B-01

KAT KAPILARI
LANDING DOOR

3 PANEL TELESKOPIK | 3 PANEL TELESCOPIC

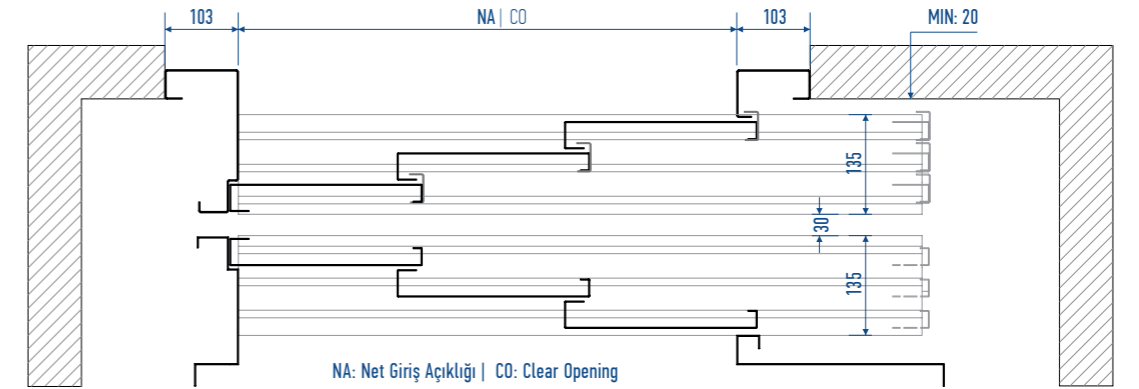

4 PANEL MERKEZİ | 4 PANEL CENTRAL

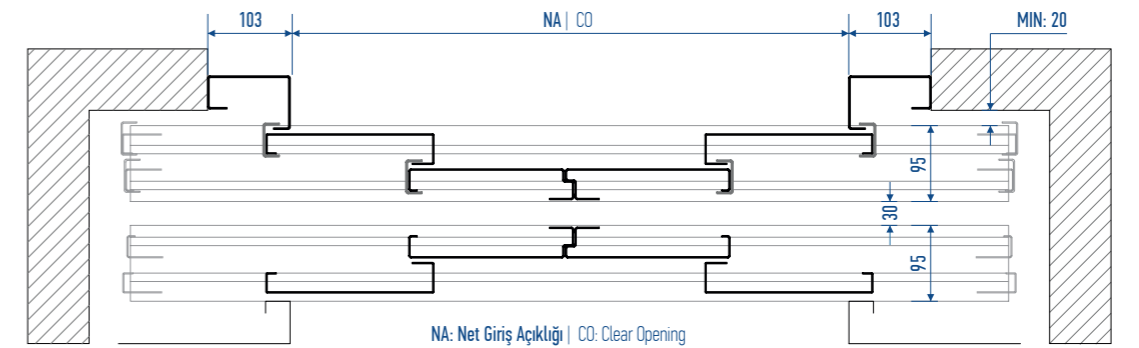
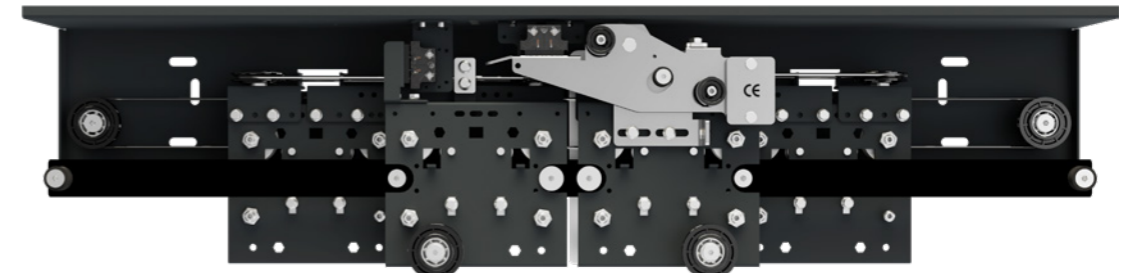

STANDART ÖZELLİKLER | STANDARD FEATURES

KAPI TİPİ DOOR TYPE	ÇİZİM DRAWING	KAPI GENİŞLİĞİ (min) DOOR WIDTH	KAPI GENİŞLİĞİ (max) DOOR WIDTH	STANDART NET GİRİŞ YÜKSEKLİĞİ STANDART CLEAR HEIGHT	MAKSİMUM NET GİRİŞ YÜKSEKLİĞİ MAX. CLEAR HEIGHT	Sızdırmazlık Sınıfı Resistant Class			YÜZEY İŞLEMLERİ SURFACE FINISHING
						E	EI	EW	
T3P		700 mm	1300 mm	2000 mm	2300 mm	120	-	20	Ral Renkleri Ral Colors Paslanmazlar Stainless
M4P		900 mm	1300 mm	2000 mm	2300 mm	120	-	30	Ral Renkleri Ral Colors Paslanmazlar Stainless

Ürünlerimiz hakkında daha detaylı bilgi almak için www.merhasansor.com adresini ziyaret ediniz.
In order to more detailed information about our products, please visit www.merhasansor.com

B-01/AV

ANTIVANDAL

"Kasıtlı tahribata karşı EN 81-71 Kategori II Kapısı"
"EN 81-71 Category II Door against intentional destruction"

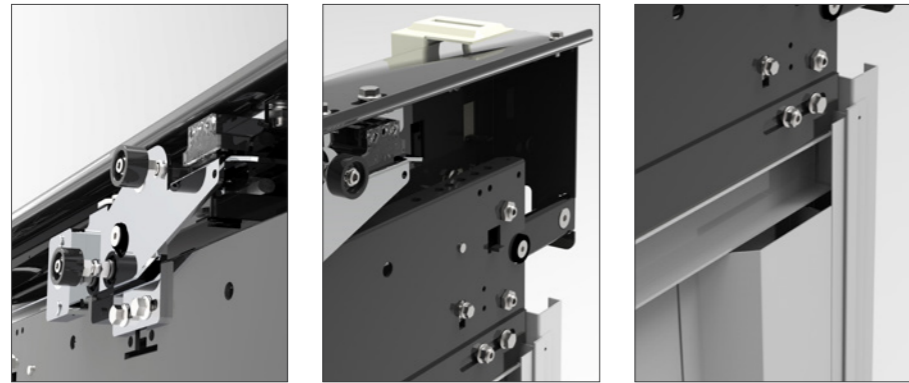

KULLANIM YERLERİ : Stadyumlar, Üst Geçitler, Tren İstasyonları, Acil Servis Bölümleri, Sosyal Konut Alanları
PLACE OF USE : Stadiums, Overpasses, Train Stations, Emergency Departments, Social Housing Areas

EN 81-20/50 | EN 81-58 | EN 81-71 | EN 81-72 | CE

MERİH

B-01

CAM KAT KAPISI
GLASS LANDING DOOR



Çerçevesiz Cam Kapı | Framed Glass Door



Tam Cam Kapılar | Full Glass Door

CAM DESENLERİ | GLASS PATTERNS



Selçuklu
Seljukian



Bahar
Spring



Kız Kulesi
The Maiden's Tower



Osmanlı
Ottoman



Hayyam



Lale
Tulip

CAM RENKLERİ | GLASS COLOURS

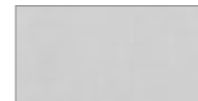

GL 001
Şeffaf | Transparent



GL 002
Yeşil | Green



GL 003
Füme | Smoked



GL 004
Mavi | Blue



GL 005
Bronz | Bronze

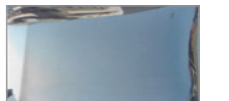

GL 006
Reflekte | Reflected

Ürünlerimiz hakkında daha detaylı bilgi almak için www.merhasansor.com adresini ziyaret ediniz.
In order to more detailed information about our products, please visit www.merhasansor.com

B-20

KAT & KABİN KAPILARI
LANDING & CAR DOOR

"Minimize edilmiş ölçülerle üstün performans."
"Superb performance with minimized dimensions."



EN 81-58 | EN 81-20 / 50 | CE

MERİH

B-20

KAT & KABİN KAPILARI
LANDING & CAR DOOR

3 PANEL TELESKOPIK | 3 PANEL TELESCOPIC
KAT KAPISI | LANDING DOOR



3 PANEL TELESKOPIK | 3 PANEL TELESCOPIC
KABİN KAPISI | CAR DOOR

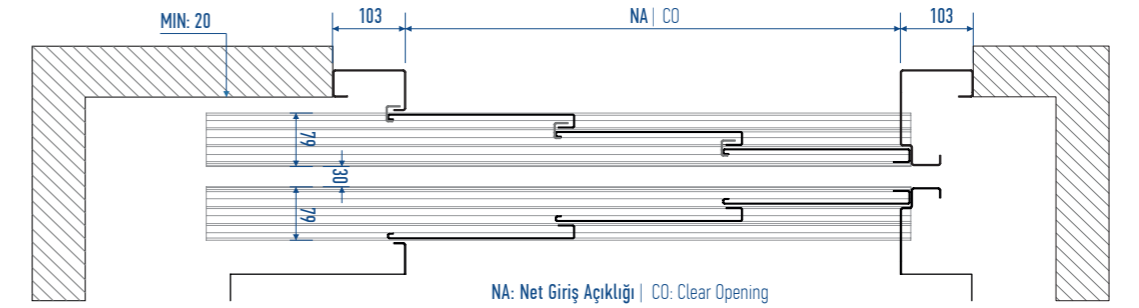
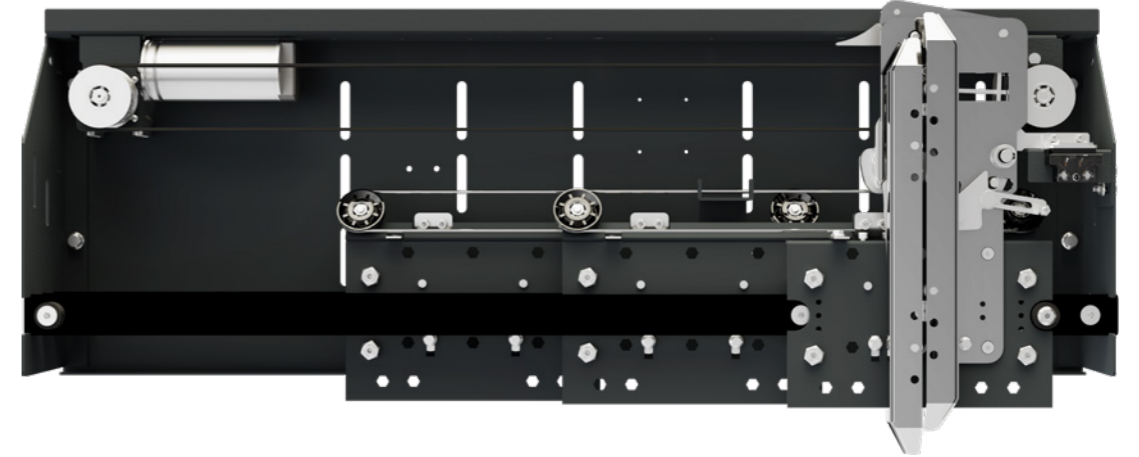

STANDART ÖZELLİKLER STANDARD FEATURES									
KAPI TİPİ DOOR TYPE	ÇİZİM DRAWING	KAPI GENİŞLİĞİ (min) DOOR WIDTH	KAPI GENİŞLİĞİ (max) DOOR WIDTH	STANDART NET GİRİŞ YÜKSEKLİĞİ STANDART CLEAR HEIGHT	MAKSİMUM NET GİRİŞ YÜKSEKLİĞİ MAX. CLEAR HEIGHT	Sızdırmazlık Sınıfı Resistant Class			YÜZEY İŞLEMLERİ SURFACE FINISHING
						E	EI	EW	
T3P		700 mm	1300 mm	2000 mm	2300 mm	120	-	20	Ral Renkleri Ral Colors Paslanmazlar Stainless

Ürünlerimiz hakkında daha detaylı bilgi almak için www.merhasansor.com adresini ziyaret ediniz.
In order to more detailed information about our products, please visit www.merhasansor.com

C-01

KAT KAPILARI
LANDING DOOR

“Güçlü konstrüksiyonu ve kolay montaj uygulaması ile yapılarınızın popüler tercihi...”
“Architecture’s popular choice with strong construction and easy installation...”



EN 81-58 | EN 81-20 / 50 | CE | EAC

MERİH

C-01

KAT KAPILARI
LANDING DOOR

2 PANEL TELESKOPIK | 2 PANEL TELESCOPIC

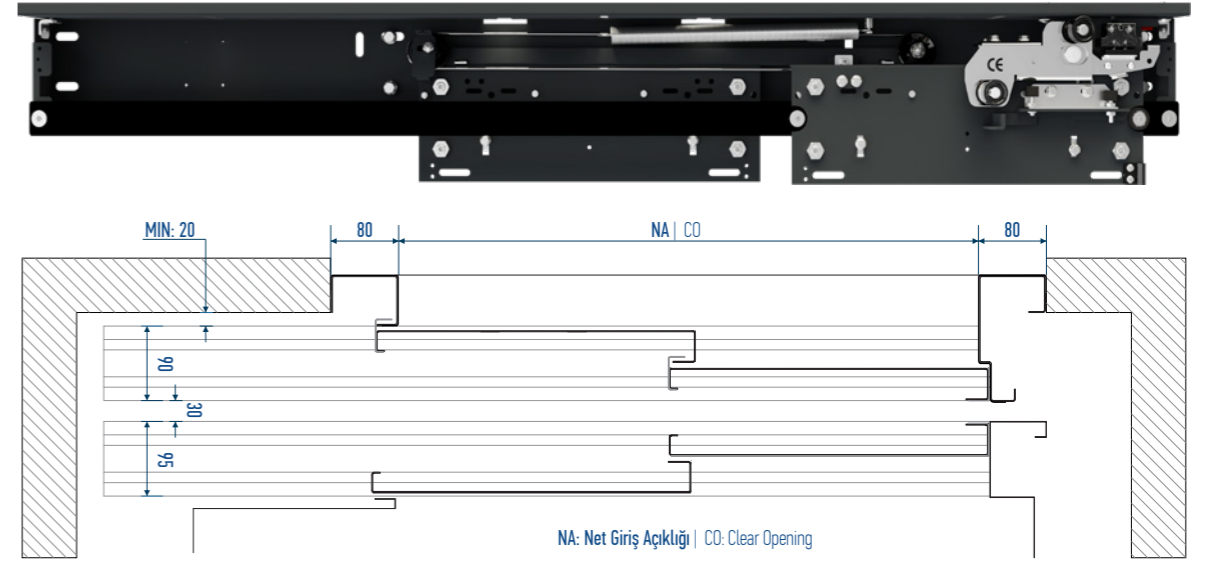

2 PANEL MERKEZİ | 2 PANEL CENTRAL

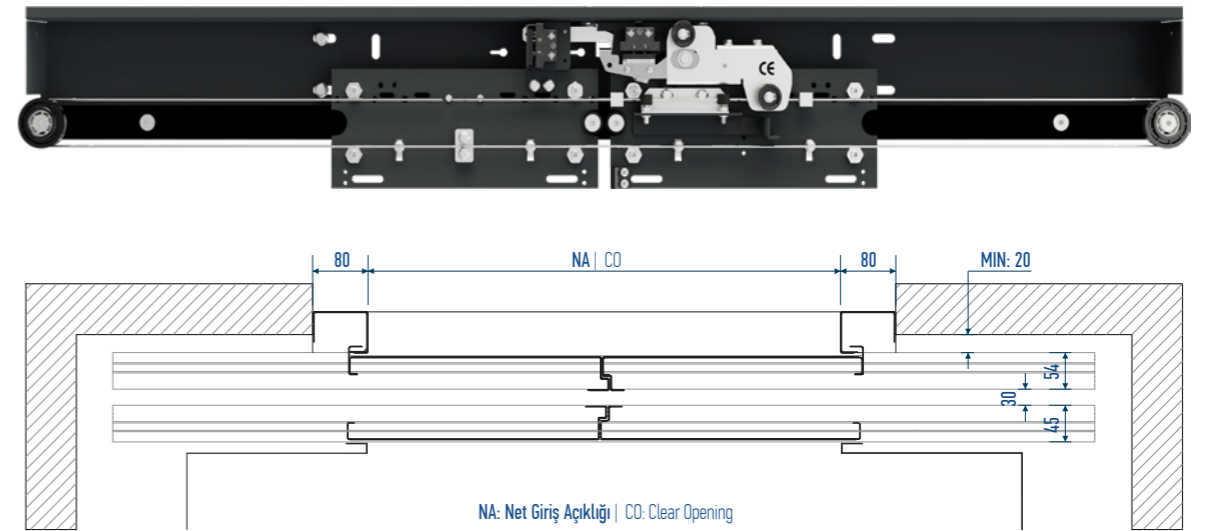

STANDART ÖZELLİKLER STANDARD FEATURES									
KAPI TİPİ DOOR TYPE	ÇİZİM DRAWING	KAPI GENİŞLİĞİ (min) DOOR WIDTH	KAPI GENİŞLİĞİ (max) DOOR WIDTH	STANDART NET GİRİŞ YÜKSEKLİĞİ STANDART CLEAR HEIGHT	MAKSİMUM NET GİRİŞ YÜKSEKLİĞİ MAX. CLEAR HEIGHT	Sızdırmazlık Sınıfı Resistant Class			YÜZEY İŞLEMLERİ SURFACE FINISHING
						E	EI	EW	
T2P		700 mm	900 mm	2000 mm	2300 mm	120	45	60	Ral Renklen Ral Colors Paslanmazlar Stainless
M2P		700 mm	900 mm	2000 mm	2300 mm	120	-	60	Ral Renklen Ral Colors Paslanmazlar Stainless

Ürünlerimiz hakkında daha detaylı bilgi almak için www.merhasansor.com adresini ziyaret ediniz.
In order to more detailed information about our products, please visit www.merhasansor.com

MERİH

E-01

KAT KAPILARI
LANDING DOOR

“Yenilikçi, sade tasarımı ve pratik montajı ile konut tipi yapıların vazgeçilmezi.”
“Innovative, pure design and easy installation door for residence type buildings.”



EN 81-20 / 50 | EN 81-58 | CE

MERİH

E-01

KAT KAPILARI
LANDING DOOR

2 PANEL TELESKOPIK | 2 PANEL TELESCOPIC

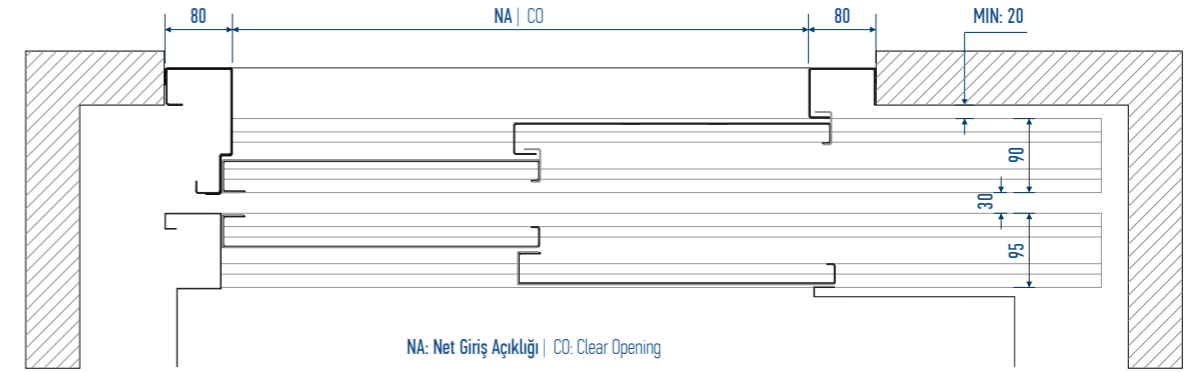

NA: Net Giriş Açıklığı | CO: Clear Opening

2 PANEL MERKEZİ | 2 PANEL CENTRAL

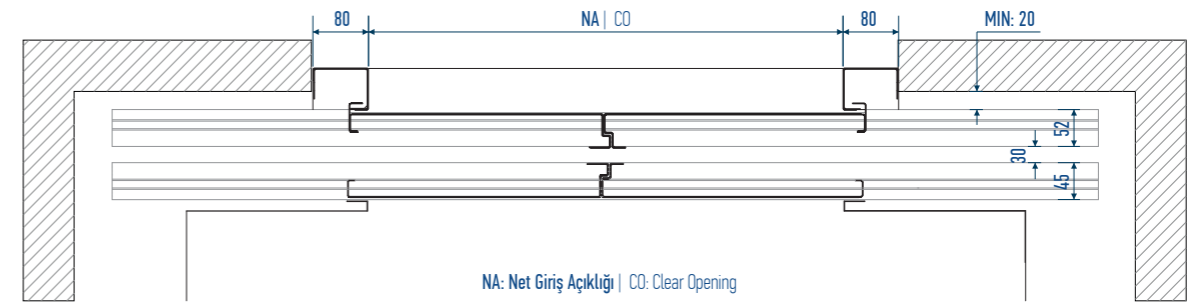
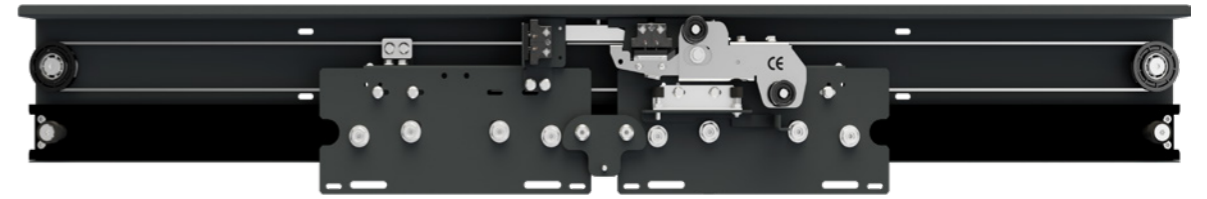

NA: Net Giriş Açıklığı | CO: Clear Opening

STANDART ÖZELLİKLER STANDARD FEATURES									
KAPI TİPİ DOOR TYPE	ÇİZİM DRAWING	KAPI GENİŞLİĞİ (min) DOOR WIDTH	KAPI GENİŞLİĞİ (max) DOOR WIDTH	STANDART NET GİRİŞ YÜKSEKLİĞİ STANDART CLEAR HEIGHT	MAKSİMUM NET GİRİŞ YÜKSEKLİĞİ MAX. CLEAR HEIGHT	Sızdırmazlık Sınıfı Resistant Class			YÜZEY İŞLEMLERİ SURFACE FINISHING
						E	EI	EW	
T2P		700 mm	900 mm	2000 mm	2100 mm	120	-	-	Ral Renkleri Ral Colors Paslanmazlar Stainless
M2P		700 mm	900 mm	2000 mm	2100 mm	120	-	-	Ral Renkleri Ral Colors Paslanmazlar Stainless

Ürünlerimiz hakkında daha detaylı bilgi almak için www.merhasansor.com adresini ziyaret ediniz.
In order to more detailed information about our products, please visit www.merhasansor.com

H-MAX

KAT KAPILARI
LANDING DOOR

"Endüstriyel yapıların yükünü hafifleten, kullanım konforu sağlayan, dayanıklı ve güçlü tercih..."
"Right choice to relieve the heaviness of industrial buildings, provides comfort during usage..."



EN 81-20 / 50 | EN 81-58 | CE

MERİH

H-MAX

KAT KAPILARI
LANDING DOOR

4 PANEL MERKEZİ | 4 PANEL CENTRAL

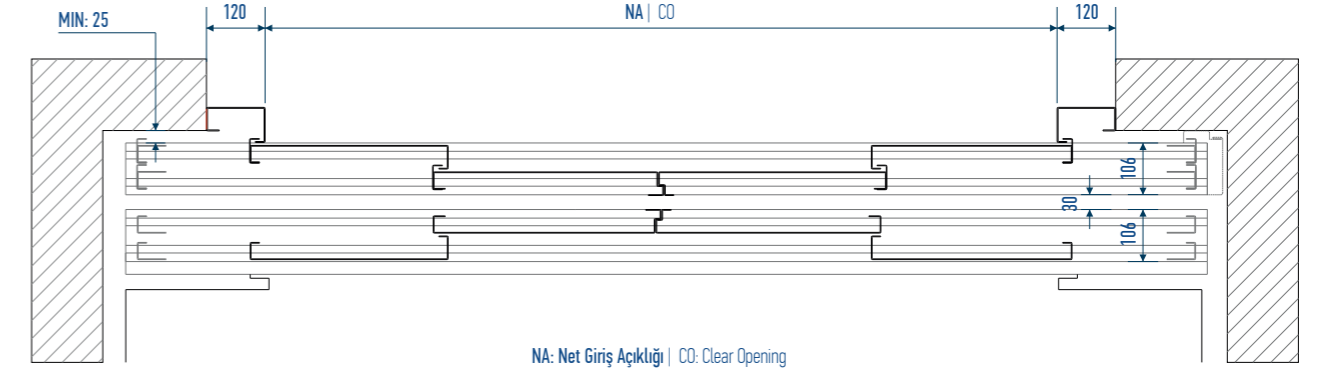
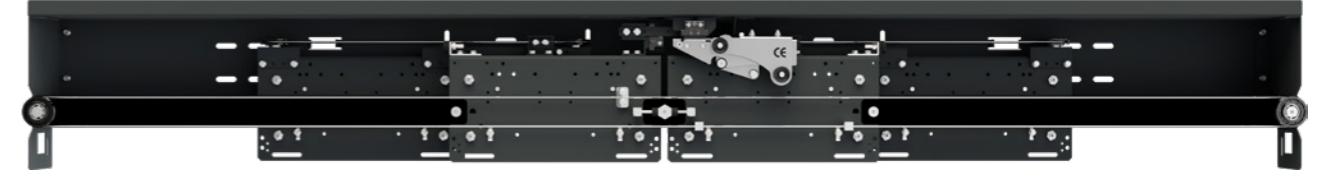

NA: Net Giriş Açıklığı | CO: Clear Opening

6 PANEL MERKEZİ | 6 PANEL CENTRAL

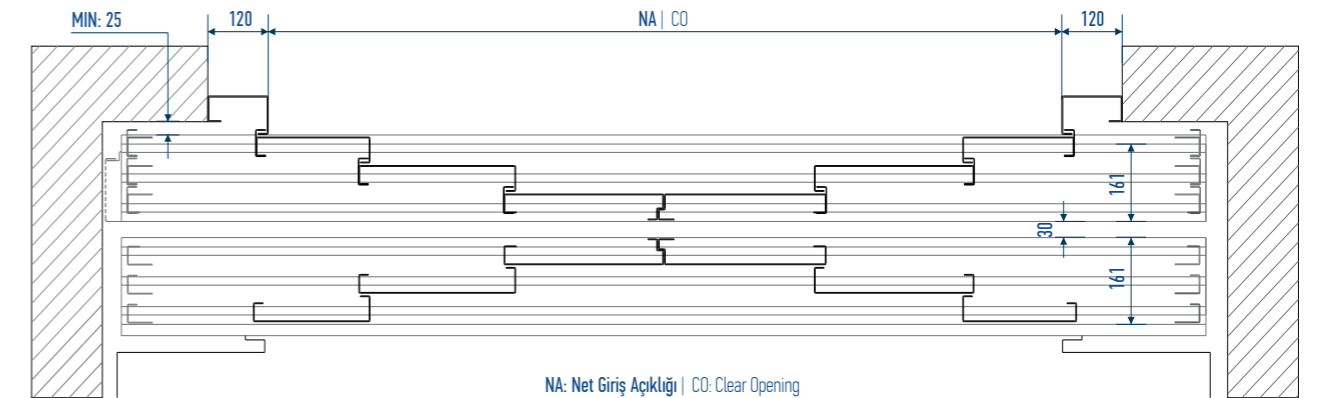
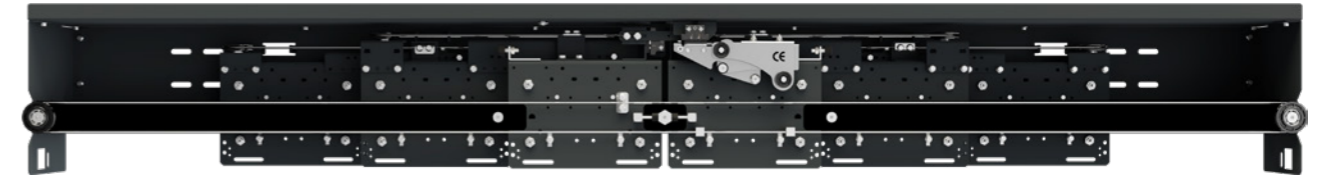

NA: Net Giriş Açıklığı | CO: Clear Opening

STANDART ÖZELLİKLER STANDARD FEATURES		KAPI GENİŞLİĞİ (min) DOOR WIDTH		STANDART NET GİRİŞ YÜKSEKLİĞİ (max) DOOR WIDTH	MAKSİMUM NET GİRİŞ YÜKSEKLİĞİ (min) DOOR WIDTH	Sızdırmazlık Sınıfı Resistant Class			YÜZEY İŞLEMLERİ FINISHING OF FRAME
KAPI TİPİ DOOR TYPE	ÇİZİM DRAWING	1400 mm	2600 mm	2000 mm	2300 mm	E	EI	EW	
M4P		1400 mm	2600 mm	2000 mm	2300 mm	120	-	-	Ral Renkleri Ral Colors Nokta Paslanmaz Pointed Stainless Steel
M6P		1400 mm	2600 mm	2000 mm	2300 mm	120	-	-	Ral Renkleri Ral Colors Nokta Paslanmaz Pointed Stainless Steel

Ürünlerimiz hakkında daha detaylı bilgi almak için www.merhasansor.com adresini ziyaret ediniz.
In order to more detailed information about our products, please visit www.merhasansor.com

MERİH

H-MAX

KABİN KAPILARI
CAR DOOR

“Endüstriyel yapıların yükünü hafifleten, kullanım konforu sağlayan, dayanıklı ve güçlü tercih...”
“Right choice to relieve the heaviness of industrial buildings, provides comfort during usage...”



EN 81-20 / 50 | CE

MERİH

H-MAX

KABİN KAPILARI
CAR DOOR

4 PANEL MERKEZİ | 4 PANEL CENTRAL

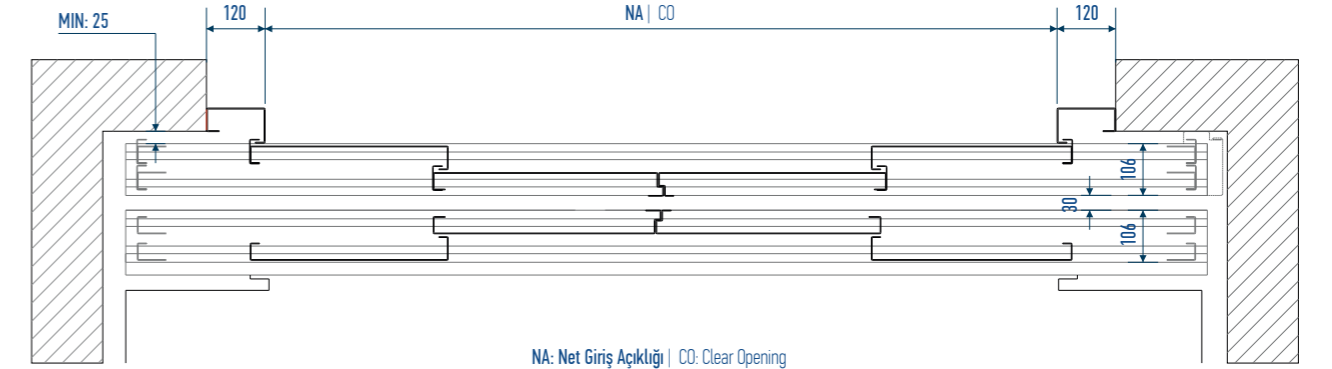
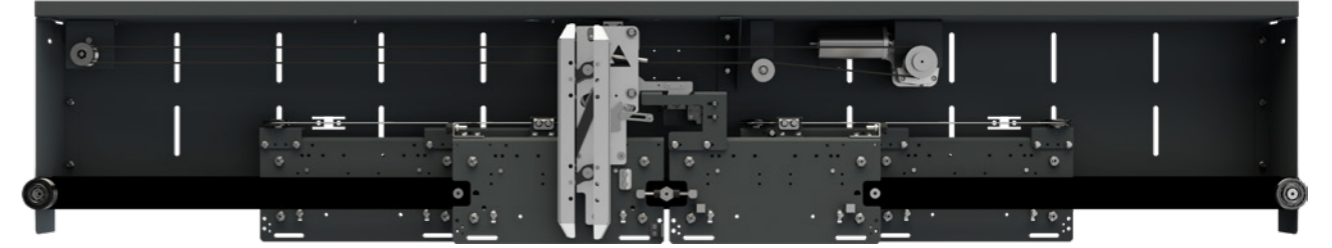

NA: Net Giriş Açıklığı | CO: Clear Opening

6 PANEL MERKEZİ | 6 PANEL CENTRAL

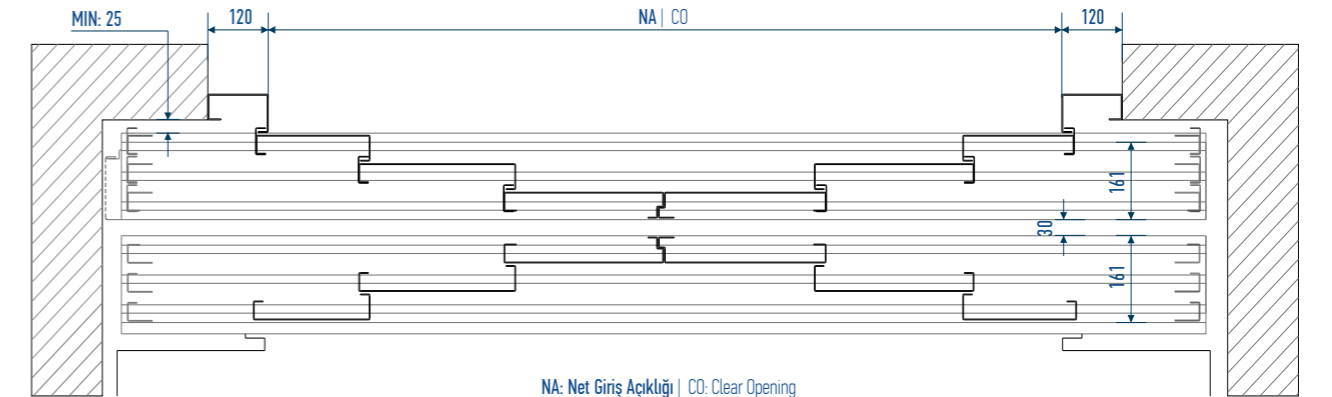
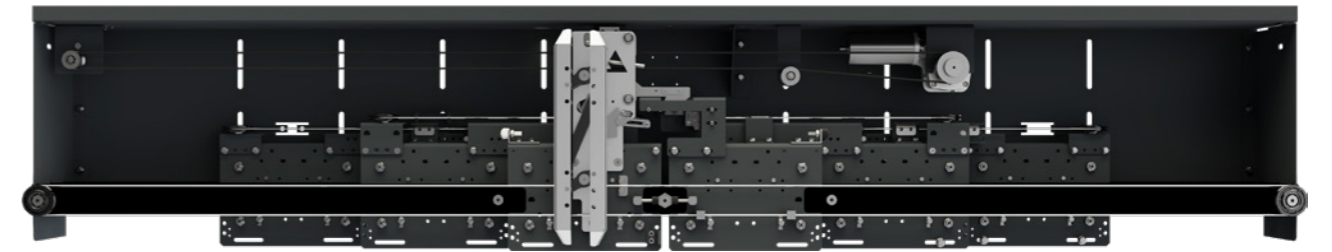

NA: Net Giriş Açıklığı | CO: Clear Opening

STANDART ÖZELLİKLER | STANDARD FEATURES

KAPI TİPİ DOOR TYPE	ÇİZİM DRAWING	KAPI GENİŞLİĞİ (min) DOOR WIDTH	KAPI GENİŞLİĞİ (max) DOOR WIDTH	STANDART NET GİRİŞ YÜKSEKLİĞİ STANDART CLEAR HEIGHT	MAKSİMUM NET GİRİŞ YÜKSEKLİĞİ MAX. CLEAR HEIGHT	YÜZEY İŞLEMLERİ SURFACE FINISHING
M6P		1400 mm	2600 mm	2000 mm	2300 mm	Ral Renkleri Ral Colors Nokta Paslanmaz Pointed Stainless Steel
M4P		1400 mm	2600 mm	2000 mm	2300 mm	Ral Renkleri Ral Colors Nokta Paslanmaz Pointed Stainless Steel

Ürünlerimiz hakkında daha detaylı bilgi almak için www.merhasansor.com adresini ziyaret ediniz.
In order to more detailed information about our products, please visit www.merhasansor.com

K - W

KABİN İÇİ GÜVENLİK KAPISI FOLDING DOOR

“Kabin içi emniyeti sağlamak isteyenlerin ideal ve güvenilir seçimi...”
“Perfect and safe choice for car inner safety in buildings with swing doors...”



TEKNİK ÖZELLİKLERİ

- 24 V DC fırçalı motor
- Elektronik sıkışma kontrolü
- Akü ve fotosel çıkışı
- 220 V AC ve LIR voltajı ile çalışabilme
- Tek sinyal (kapama sinyali) ile çalışabilme
- Kontak tipinin NO/NC olarak ayarlanabilme

TECHNICAL SPECIFICATIONS

- 24 V DC brushed motor
- Electronic jam control
- Accumulator and photocell control
- Ability to operate with 220 V AC and LIR
- Ability to operate with single (close signal)
- Adjustment of short circuit as NO/NC

STANDART ÖZELLİKLER STANDARD FEATURES							
KAPI TİPİ DOOR TYPE	ÇİZİM DRAWING	MONTAJ GENİŞLİĞİ (min) INSTALLATION WIDTH	NET GENİŞLİK (min) CLEAR OPENING	MONTAJ GENİŞLİĞİ (max) INSTALLATION WIDTH	NET GENİŞLİK (max) CLEAR OPENING	STANDART STANDARD	YÜZEY İŞLEMLERİ SURFACE FINISHING
K-W		700 mm	625 mm	1500 mm	1425 mm	TSEK 525	Ral Renkleri Ral Colors Paslanmazlar Stainless

Ürünlerimiz hakkında daha detaylı bilgi almak için www.merhasansor.com adresini ziyaret ediniz.
In order to more detailed information about our products, please visit www.merhasansor.com

K - D

KABİN İÇİ GÜVENLİK KAPISI FOLDING DOOR

“Kabin içi emniyeti sağlamak isteyenlerin ideal ve güvenilir seçimi...”
“Perfect and safe choice for car inner safety in buildings with swing doors...”



TEKNİK ÖZELLİKLERİ

- 24 V DC fırçalı motor
- Elektronik sıkışma kontrolü
- Akü ve fotosel çıkışı
- 220 V AC ve LIR voltajı ile çalışabilme
- Tek sinyal (kapama sinyali) ile çalışabilme
- Kontak tipinin NO / NC olarak ayarlanabilmesi

TECHNICAL SPECIFICATIONS

- 24 V DC brushed motor
- Electronic jam control
- Accumulator and photocell control
- Ability to operate with 220 V AC and LIR
- Ability to operate with single (close signal)
- Adjustment of short circuit as NO/NC

STANDART ÖZELLİKLER STANDARD FEATURES							
KAPI TİPİ DOOR TYPE	ÇİZİM DRAWING	MONTAJ GENİŞLİĞİ (min) INSTALLATION WIDTH	NET GENİŞLİK (min) CLEAR OPENING	MONTAJ GENİŞLİĞİ (max) INSTALLATION WIDTH	NET GENİŞLİK (max) CLEAR OPENING	STANDART STANDARD	YÜZEY İŞLEMLERİ SURFACE FINISHING
K-W		700 mm	625 mm	950 mm	875 mm	TSEK 525	Ral Renkleri Ral Colors Paslanmazlar Stainless

Ürünlerimiz hakkında daha detaylı bilgi almak için www.merhasansor.com adresini ziyaret ediniz.
In order to more detailed information about our products, please visit www.merhasansor.com

SD-01

YARI OTOMATİK KAPILAR
SEMI-AUTOMATIC DOORS

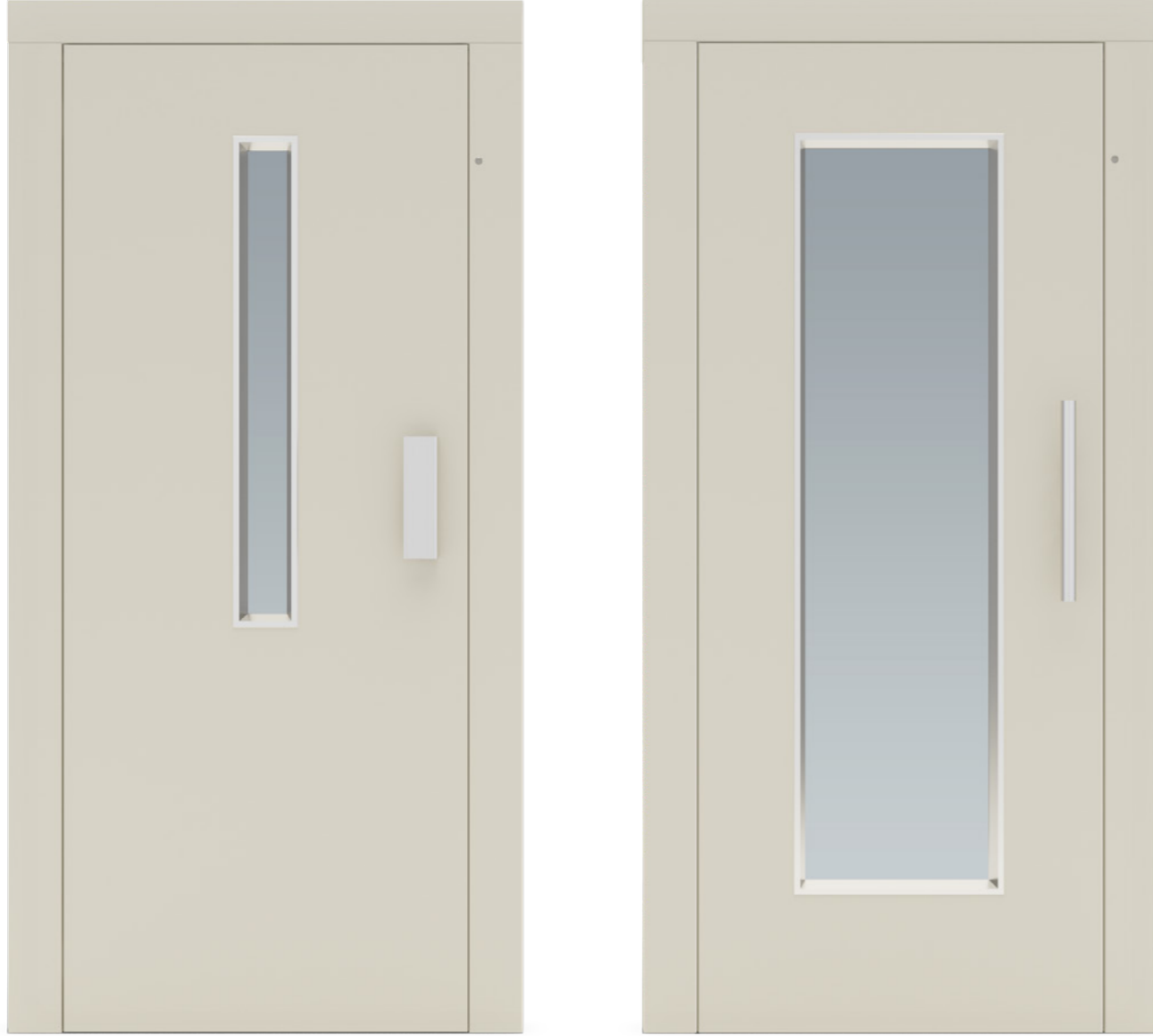

TEKNİK ÖZELLİKLERİ

- Kapı boyunda kuvvetlendirilmiş destek sistemi
- Gizli çelik menteşe ile yüksek taşıma kapasitesi
- Paslanmaz yüzey kaplama seçeneği
- 120 derece açılabilme özelliği
- Montaj kolaylığı ve sorunsuz kullanım
- Net giriş ölçüsü: 700-1100 mm
- EN 81:58'e göre - E 120

TECHNICAL SPECIFICATIONS

- Reinforced support system along door height
- High carrying capacity with hidden steel hinge
- Stainless steel surface finishing option
- Ability to open 120 degrees
- Easy installation and trouble-free use
- Clear entrance dimensions: 700-1100 mm
- Compliant with EN 81-58 - E 120

Ürünlerimiz hakkında daha detaylı bilgi almak için www.merihansor.com adresini ziyaret ediniz.
In order to more detailed information about our products, please visit www.merihansor.com

SD-01

YARI OTOMATİK KAPILAR
SEMI-AUTOMATIC DOORS

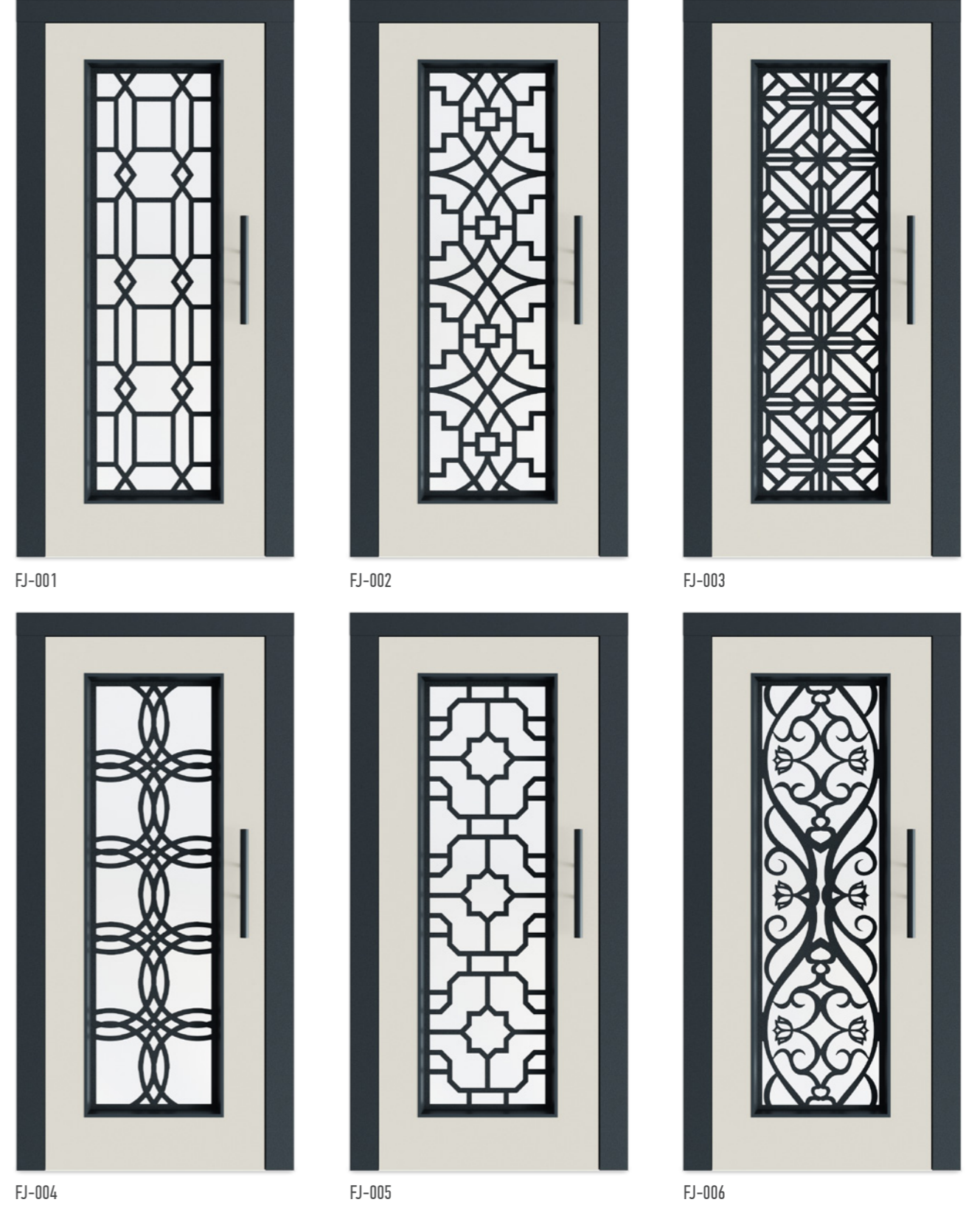

Ürünlerimiz hakkında daha detaylı bilgi almak için www.merihansor.com adresini ziyaret ediniz.
In order to more detailed information about our products, please visit www.merihansor.com

GIYOTİN KAPI GUILLOTINE DOOR



TEKNİK ÖZELLİKLERİ

- Üst panel denge sistemi ile kolay açılabilme
- Ayar tamponları ile giriş yükseklik ayarı
- Genişlik: 500-1000 mm aralığında
- Yükseklik: 500-1000 mm aralığında
- Giyotin ve manuel açılma seçeneği

TECHNICAL SPECIFICATIONS

- Upper panel balance system provides easy opening
- Opening height adjustment with setting buffers
- Width: 500-1000 mm range
- Height: 500-1000 mm range
- Guillotine and manual opening option

Ürünlerimiz hakkında daha detaylı bilgi almak için www.merhasansor.com adresini ziyaret ediniz.
In order to more detailed information about our products, please visit www.merhasansor.com

KABİNLER CABINS

YUNUS



TEKNİK ÖZELLİKLER

YAN DUVAR	RAL7032	Elektrostatik Boya
ARKA DUVAR	RAL7032	Elektrostatik Boya
AKSESUAR	RAL7032	Elektrostatik Boya
GÖNYE - BAŞLIK	RAL7032	Elektrostatik Boya
TABAN	PVC005	PVC Gri
TAVAN	CL 034	Elektrostatik Boya - Pleksi
AYDINLATMA	LED AMPL	Led Ampül
KÜPEŞTE	BPB-K	Paslanmaz - Arka I
AYNA	YBRL	Yarım Boy Rodajlı Lamine
STANDART	EN 81-20 • EN 81-70	

TECHNICAL SPECIFICATIONS

SIDE WALL	RAL7032	Electrostatic Painted
BACK WALL	RAL7032	Electrostatic Painted
ACCESSORY	RAL7032	Electrostatic Painted
ENTRANCE SIDES & HEADER	RAL7032	Electrostatic Painted
FLOOR	PVC005	PVC Grey
CEILING	CL 034	Electrostatic Painted - Plexi
LIGHTING	LED AMPL	Led Bulb
HANDRAIL	BPB-K	Stainless Steel - Back I
MIRROR	YBRL	Half Length Grinding Laminated
STANDARD	EN 81-20 • EN 81-70	



Zemin ve aksesuarlar opsiyoneldir. Görsel temsilidir. Ürün teknik ve görsel açıdan farklılık gösterebilir.
Floor and accessories are optional. The product image is representative. The actual product may vary technically or visually from the image.

MOZART



TEKNİK ÖZELLİKLER

YAN DUVAR	PSL001	Satine Paslanmaz
ARKA DUVAR	PSL001	Satine Paslanmaz
AKSESUAR	PSL001	Satine Paslanmaz
GÖNYE - BAŞLIK	PSL001	Satine Paslanmaz
TABAN	PVC005	PVC Gri
TAVAN	CL 034	Satine Paslanmaz - Pleksi
AYDINLATMA	LED AMPL	Led Ampül
KÜPEŞTE	BPB-K	Paslanmaz - Arka I
AYNA	YBRL	Yarım Boy Rodajlı Lamine
STANDART	EN 81-20 • EN 81-70	

TECHNICAL SPECIFICATIONS

SIDE WALL	PSL001	Hairline Stainless Steel
BACK WALL	PSL001	Hairline Stainless Steel
ACCESSORY	PSL001	Hairline Stainless Steel
ENTRANCE SIDES & HEADER	PSL001	Hairline Stainless Steel
FLOOR	PVC005	PVC Grey
CEILING	CL 034	Hairline Stainless Steel - Plexi
LIGHTING	LED AMPL	Led Bulb
HANDRAIL	BPB-K	Stainless Steel - Back I
MIRROR	YBRL	Half Length Grinding Laminated
STANDARD	EN 81-20 • EN 81-70	



CHOPIN



TEKNİK ÖZELLİKLER

YAN DUVAR	PSL001	Satine Paslanmaz
ARKA DUVAR	PSL001	Satine Paslanmaz
AKSESUAR	PSL001	Satine Paslanmaz
GÖNYE - BAŞLIK	PSL001	Satine Paslanmaz
TABAN	PVC005	PVC Gri
TAVAN	CL 051	Satine Paslanmaz - Pleksi
AYDINLATMA	LED AMPL	Led Ampül
KÜPEŞTE	BPB-K	Paslanmaz - Arka 1
AYNA	TBRL	Tam Boy Rodajlı Lamine
STANDART	EN 81-20 • EN 81-70	

TECHNICAL SPECIFICATIONS

SIDE WALL	PSL001	Hairline Stainless Steel
BACK WALL	PSL001	Hairline Stainless Steel
ACCESSORY	PSL001	Hairline Stainless Steel
ENTRANCE SIDES & HEADER	PSL001	Hairline Stainless Steel
FLOOR	PVC005	PVC Grey
CEILING	CL 051	Hairline Stainless Steel - Plexi
LIGHTING	LED AMPL	Led Bulb
HANDRAIL	BPB-K	Stainless Steel - Back I
MIRROR	TBRL	Full Length Grinding Laminated
STANDARD	EN 81-20 • EN 81-70	



Zemin ve aksesuarlar opsiyoneldir. Görsel temsilidir. Ürün teknik ve görsel açıdan farklılık gösterebilir.
Floor and accessories are optional. The product image is representative. The actual product may vary technically or visually from the image.

TESLA



TEKNİK ÖZELLİKLER

YAN DUVAR	PSL001	Satine Paslanmaz
ARKA DUVAR	PSL001	Satine Paslanmaz
AKSESUAR	PSL001	Satine Paslanmaz
GÖNYE - BAŞLIK	PSL001	Satine Paslanmaz
TABAN	PVC002	PVC Mavi
TAVAN	CL 027	Satine Paslanmaz - Pleksi
AYDINLATMA	LED AMPL	Led Ampül
KÜPEŞTE	BPB-K	Paslanmaz - Arka 1
AYNA	TBRL	Tam Boy Rodajlı Lamine
STANDART	EN 81-20 • EN 81-70	

TECHNICAL SPECIFICATIONS

SIDE WALL	PSL001	Hairline Stainless Steel
BACK WALL	PSL001	Hairline Stainless Steel
ACCESSORY	PSL001	Hairline Stainless Steel
ENTRANCE SIDES & HEADER	PSL001	Hairline Stainless Steel
FLOOR	PVC002	PVC Blue
CEILING	CL 027	Hairline Stainless Steel - Plexi
LIGHTING	LED AMPL	Led Bulb
HANDRAIL	BPB-K	Stainless Steel - Back I
MIRROR	TBRL	Full Length Grinding Laminated
STANDARD	EN 81-20 • EN 81-70	



ARCHIMED



TEKNİK ÖZELLİKLER

YAN DUVAR	PSL001	Satine Paslanmaz
ARKA DUVAR	RAL5008	Elektrostatik Boya
AKSESUAR	RAL5008	Elektrostatik Boya
GÖNYE - BAŞLIK	PSL001	Satine Paslanmaz
TABAN	PVC005	PVC Gri
TAVAN	CL 058	Satine Paslanmaz
AYDINLATMA	LS	Led Spot
KÜPEŞTE	BPB	Paslanmaz - Arka I
AYNA	TBRL	Tam Boy Rodajlı Lamine
STANDART	EN 81-20 • EN 81-70	

TECHNICAL SPECIFICATIONS

SIDE WALL	PSL001	Hairline Stainless Steel
BACK WALL	RAL5008	Electrostatic Painted
ACCESSORY	RAL5008	Electrostatic Painted
ENTRANCE SIDES & HEADER	PSL001	Hairline Stainless Steel
FLOOR	PVC005	PVC Grey
CEILING	CL 058	Hairline Stainless Steel
LIGHTING	LS	Led Spot
HANDRAIL	BPB	Stainless Steel - Back I
MIRROR	TBRL	Full Length Grinding Laminated
STANDARD	EN 81-20 • EN 81-70	



Zemin ve aksesuarlar opsiyoneldir. Görsel temsildir. Ürün teknik ve görsel açıdan farklılık gösterebilir.
Floor and accessories are optional. The product image is representative. The actual product may vary technically or visually from the image.

SİNA



TEKNİK ÖZELLİKLER

YAN DUVAR	CR180-6	RAL180-6 Boyalı Cam
ARKA DUVAR	RAL9003	Elektrostatik Boya
AKSESUAR	PSL001	Satine Paslanmaz
GÖNYE - BAŞLIK	PSL001	Satine Paslanmaz
TABAN	PVC005	PVC Gri
TAVAN	CL 058	RAL9003 Elektrostatik Boya
AYDINLATMA	LS	Led Spot
KÜPEŞTE	BPB	Paslanmaz - Arka I
AYNA	TBRL	Tam Boy Rodajlı Lamine
STANDART	EN 81-20 • EN 81-70	

TECHNICAL SPECIFICATIONS

SIDE WALL	CR180-6	RAL180-6 Painted Glass
BACK WALL	RAL9003	Electrostatic Painted
ACCESSORY	PSL001	Hairline Stainless Steel
ENTRANCE SIDES & HEADER	PSL001	Hairline Stainless Steel
FLOOR	PVC005	PVC Grey
CEILING	CL 058	RAL9003 Electrostatic Painted
LIGHTING	LS	Led Spot
HANDRAIL	BPB	Stainless Steel - Back I
MIRROR	TBRL	Full Length Grinding Laminated
STANDARD	EN 81-20 • EN 81-70	



EUCLID



TEKNİK ÖZELLİKLER

YAN DUVAR	RAL1019	Elektrostatik Boya
ARKA DUVAR	RAL9003	Elektrostatik Boya
AKSESUAR	PSL001	Satine Paslanmaz
GÖNYE - BAŞLIK	PSL001	Satine Paslanmaz
TABAN	PVC005	PVC Gri
TAVAN	CL 058	RAL9003 Elektrostatik Boya
AYDINLATMA	LS	Led Spot
KÜPEŞTE	BPB	Paslanmaz - Arka I
AYNA	TBRL	Tam Boy Rodajlı Lamine
STANDART	EN 81-20 • EN 81-70	

TECHNICAL SPECIFICATIONS

SIDE WALL	RAL1019	Electrostatic Painted
BACK WALL	RAL9003	Electrostatic Painted
ACCESSORY	PSL001	Hairline Stainless Steel
ENTRANCE SIDES & HEADER	PSL001	Hairline Stainless Steel
FLOOR	PVC005	PVC Grey
CEILING	CL 058	RAL9003 Electrostatic Painted
LIGHTING	LS	Led Spot
HANDRAIL	BPB	Stainless Steel - Back I
MIRROR	TBRL	Full Length Grinding Laminated
STANDARD	EN 81-20 • EN 81-70	



Zemin ve aksesuarlar opsiyoneldir. Görsel temsildir. Ürün teknik ve görsel açıdan farklılık gösterebilir.
Floor and accessories are optional. The product image is representative. The actual product may vary technically or visually from the image.

RAPHAEL



TEKNİK ÖZELLİKLER

YAN DUVAR	M03003	Laminant
ARKA DUVAR	M03001	Laminant
AKSESUAR	PSL001	Satine Paslanmaz
GÖNYE - BAŞLIK	PSL001	Satine Paslanmaz
TABAN	PVC005	PVC Gri
TAVAN	CL 034	Satine Paslanmaz - Pleksi
AYDINLATMA	LED AMPL	Led Ampül
KÜPEŞTE	BPB-K	Paslanmaz - Sağ I
AYNA	TBRL	Tam Boy Rodajlı Lamine
STANDART	EN 81-20 • EN 81-70	

TECHNICAL SPECIFICATIONS

SIDE WALL	M03003	Laminate
BACK WALL	M03001	Laminate
ACCESSORY	PSL001	Hairline Stainless Steel
ENTRANCE SIDES & HEADER	PSL001	Hairline Stainless Steel
FLOOR	PVC005	PVC Grey
CEILING	CL 034	Hairline Stainless Steel - Plexi
LIGHTING	LED AMPL	Led Bulb
HANDRAIL	BPB-K	Stainless Steel - Back I
MIRROR	TBRL	Full Length Grinding Laminated
STANDARD	EN 81-20 • EN 81-70	



BALZAC



TEKNİK ÖZELLİKLER

YAN DUVAR	PSL001	Satine Paslanmaz
ARKA DUVAR	PSL001	Satine Paslanmaz
AKSESUAR	DM-01	Dekoratif Paslanmaz
GÖNYE - BAŞLIK	DM-01	Dekoratif Paslanmaz
TABAN	BS 044	Kompoze Taş Nepilia
TAVAN	CL 034	Satine Paslanmaz - Pleksi
AYDINLATMA	LED AMPL	Led Ampül
KÜPEŞTE	BPB	Paslanmaz - Arka I
AYNA	YBRL	Yarım Boy Rodajlı Lamine
STANDART		EN 81-20 • EN 81-70

TECHNICAL SPECIFICATIONS

SIDE WALL	PSL001	Hairline Stainless Steel
BACK WALL	PSL001	Hairline Stainless Steel
ACCESSORY	DM-01	Decorative Stainless Steel
ENTRANCE SIDES & HEADER	DM-01	Decorative Stainless Steel
FLOOR	BS 044	Artificial Stone Nepilia
CEILING	CL 034	Hairline Stainless Steel - Plexi
LIGHTING	LED AMPL	Led Bulb
HANDRAIL	BPB	Stainless Steel - Back I
MIRROR	YBRL	Half Length Grinding Laminated
STANDARD		EN 81-20 • EN 81-70



Zemin ve aksesuarlar opsiyoneldir. Görsel temsildir. Ürün teknik ve görsel açıdan farklılık gösterebilir.
Floor and accessories are optional. The product image is representative. The actual product may vary technically or visually from the image.

DA VINCI



TEKNİK ÖZELLİKLER

YAN DUVAR	CR6027	RAL6027 Boyalı Cam
ARKA DUVAR	DM-01	Dekoratif Paslanmaz
AKSESUAR	DM-01	Dekoratif Paslanmaz
GÖNYE - BAŞLIK	DM-01	Dekoratif Paslanmaz
TABAN	BS005	Kompoze Taş
TAVAN	CL 050	Satine Paslanmaz
AYDINLATMA	LS	Led Spot
KÜPEŞTE	BPB	Paslanmaz - Arka I
AYNA	TBRL	Tam Boy Rodajlı Lamine
STANDART		EN 81-20 • EN 81-70

TECHNICAL SPECIFICATIONS

SIDE WALL	CR6027	RAL6027 Painted Glass
BACK WALL	DM-01	Decorative Stainless Steel
ACCESSORY	DM-01	Decorative Stainless Steel
ENTRANCE SIDES & HEADER	DM-01	Decorative Stainless Steel
FLOOR	BS005	Artificial Stone
CEILING	CL 050	Hairline Stainless Steel
LIGHTING	LS	Led Spot
HANDRAIL	BPB	Stainless Steel - Back I
MIRROR	TBRL	Full Length Grinding Laminated
STANDARD		EN 81-20 • EN 81-70



CURIE



TEKNİK ÖZELLİKLER

YAN DUVAR	RAL5014	Elektrostatik Boyalı
ARKA DUVAR	PSL001	Satine Paslanmaz
AKSESUAR	PSL001	Satine Paslanmaz
GÖNYE - BAŞLIK	PSL001	Satine Paslanmaz
TABAN	PVC005	PVC Gri
TAVAN	CL 034	RAL9003 Elektrostatik Boyalı - Pleksi
AYDINLATMA	LED AMPL	Led Ampül
KÜPEŞTE	BPB	Paslanmaz - Arka I
AYNA	TBRL	Tam Boy Rodajlı Lamine
STANDART		EN 81-20 • EN 81-70

TECHNICAL SPECIFICATIONS

SIDE WALL	RAL5014	Electrostatic Painted
BACK WALL	PSL001	Hairline Stainless Steel
ACCESSORY	PSL001	Hairline Stainless Steel
ENTRANCE SIDES & HEADER	PSL001	Hairline Stainless Steel
FLOOR	PVC005	PVC Grey
CEILING	CL 034	RAL9003 Electrostatic Painted - Plexi
LIGHTING	LED AMPL	Led Bulb
HANDRAIL	BPB	Stainless Steel - Back I
MIRROR	TBRL	Full Length Grinding Laminated
STANDARD		EN 81-20 • EN 81-70



Zemin ve aksesuarlar opsiyoneldir. Görsel temsildir. Ürün teknik ve görsel açıdan farklılık gösterebilir.
Floor and accessories are optional. The product image is representative. The actual product may vary technically or visually from the image.

HAREZMİ



TEKNİK ÖZELLİKLER

YAN DUVAR	M13467	Laminant
ARKA DUVAR	M13467	Laminant
AKSESUAR	PSL001	Satine Paslanmaz
GÖNYE - BAŞLIK	PSL001	Satine Paslanmaz
TABAN	BS 037	Kompoze Taş Lebedos
TAVAN	CL 058	Satine Paslanmaz
AYDINLATMA	LS	Led Spot
KÜPEŞTE	BPB	Paslanmaz - Arka I
AYNA	YBRL	Yarım Boy Rodajlı Lamine
STANDART		EN 81-20 • EN 81-70

TECHNICAL SPECIFICATIONS

SIDE WALL	M13467	Laminate
BACK WALL	M13467	Laminate
ACCESSORY	PSL001	Hairline Stainless Steel
ENTRANCE SIDES & HEADER	PSL001	Hairline Stainless Steel
FLOOR	BS 037	Artificial Stone Lebedos
CEILING	CL 058	Hairline Stainless Steel
LIGHTING	LS	Led Spot
HANDRAIL	BPB	Stainless Steel - Back I
MIRROR	YBRL	Half Length Grinding Laminated
STANDARD		EN 81-20 • EN 81-70



BEETHOVEN



TEKNİK ÖZELLİKLER

YAN DUVAR	PSL001	Satine Paslanmaz
ARKA DUVAR	PSL001	Satine Paslanmaz
AKSESUAR	DM01	Dekoratif Paslanmaz
GÖNYE - BAŞLIK	PSL001	Satine Paslanmaz
TABAN	BS 039	Kompoze Taş Savana
TAVAN	CL 034	Satine Paslanmaz - Pleksi
AYDINLATMA	LED AMPL	Led Ampül
KÜPEŞTE	BPB	Paslanmaz - Arka I
AYNA	TBRL	Tam Boy Rodajlı Lamine
STANDART		EN 81-20 • EN 81-70

TECHNICAL SPECIFICATIONS

SIDE WALL	PSL001	Hairline Stainless Steel
BACK WALL	PSL001	Hairline Stainless Steel
ACCESSORY	DM-01	Decorative Stainless Steel
ENTRANCE SIDES & HEADER	PSL001	Hairline Stainless Steel
FLOOR	BS 039	Artificial Stone Savana
CEILING	CL 034	Elektrostatik Boya - Plexi
LIGHTING	LED AMPL	Led Bulb
HANDRAIL	BPB	Stainless Steel - Back I
MIRROR	TBRL	Full Length Grinding Laminated
STANDARD		EN 81-20 • EN 81-70



Zemin ve aksesuarlar opsiyoneldir. Görsel temsilidir. Ürün teknik ve görsel açıdan farklılık gösterebilir.
Floor and accessories are optional. The product image is representative. The actual product may vary technically or visually from the image.

PISAGOR



TEKNİK ÖZELLİKLER

KAPLAMA I	DB-SB / BLACK	Dekoratif Paslanmaz
KAPLAMA II	DG-01	Dekoratif Paslanmaz
AKSESUAR	DB-SB / BLACK	Dekoratif Paslanmaz
GÖNYE - BAŞLIK	DB-SB / BLACK	Dekoratif Paslanmaz
TABAN	BS025	Doğal Taş
TAVAN	CL 058	DM-01 Dekoratif Paslanmaz
AYDINLATMA	LS	Led Spot
KÜPEŞTE	SPB	Paslanmaz - Arka I
AYNA	TBRL	Tam Boy Rodajlı Lamine
STANDART		EN 81-20 • EN 81-70

TECHNICAL SPECIFICATIONS

COATING I	DB-SB / BLACK	Decorative Stainless Steel
COATING II	DG-01	Decorative Stainless Steel
ACCESSORY	DB-SB / BLACK	Decorative Stainless Steel
ENTRANCE SIDES & HEADER	DB-SB / BLACK	Decorative Stainless Steel
FLOOR	BS 025	Real Stone
CEILING	CL 058	DM-01 Decorative Stainless Steel
LIGHTING	LS	Led Spot
HANDRAIL	BPB	Stainless Steel - Back I
MIRROR	TBRL	Full Length Grinding Laminated
STANDARD		EN 81-20 • EN 81-70



PICASSO



TEKNİK ÖZELLİKLER

YAN DUVAR	GL008	Boyalı Cam
ARKA DUVAR	GL007	Boyalı Cam
AKSESUAR	DM-01	Dekoratif Paslanmaz
GÖNYE - BAŞLIK	DM-01	Dekoratif Paslanmaz
TABAN	RAL7036	Boyalı Cam
TAVAN	CL 034	RAL9003 Elektrostatik Boya - Pleksi
AYDINLATMA	LED AMPL	Led Ampül
KÜPEŞTE	BPB	Paslanmaz - Arka I
AYNA	YBRL	Yarım Boy Rodajlı Lamine
STANDART		EN 81-20 • EN 81-70

TECHNICAL SPECIFICATIONS

SIDE WALL	GL008	Painted Glass
BACK WALL	GL007	Painted Glass
ACCESSORY	DM-01	Decorative Stainless Steel
ENTRANCE SIDES & HEADER	DM-01	Decorative Stainless Steel
FLOOR	RAL7036	Painted Glass
CEILING	CL 034	RAL9003 Electrostatic Painted - Plexi
LIGHTING	LED AMPL	Led Bulb
HANDRAIL	BPB	Stainless Steel - Back I
MIRROR	YBRL	Half Length Grinding Laminated
STANDARD		EN 81-20 • EN 81-70



Zemin ve aksesuarlar opsiyoneldir. Görsel temsilidir. Ürün teknik ve görsel açıdan farklılık gösterebilir.
Floor and accessories are optional. The product image is representative. The actual product may vary technically or visually from the image.

ARISTO



TEKNİK ÖZELLİKLER

YAN DUVAR	M8814-2 MSM233	Laminant
ARKA DUVAR	M8814-2 MSM233	Laminant
AKSESUAR	PSL001	Satine Paslanmaz
GÖNYE - BAŞLIK	PSL001	Satine Paslanmaz
TABAN	BS005	Kompoze Taş
TAVAN	CL 034	Satine Paslanmaz - Pleksi
AYDINLATMA	LED AMPL	Led Ampül
KÜPEŞTE	BPB	Paslanmaz - Arka I
AYNA	TBRL	Tam Boy Rodajlı Lamine
STANDART		EN 81-20 • EN 81-70

TECHNICAL SPECIFICATIONS

SIDE WALL	M8814-2 MSM233	Laminate
BACK WALL	M8814-2 MSM233	Laminate
ACCESSORY	PSL001	Hairline Stainless Steel
ENTRANCE SIDES & HEADER	PSL001	Hairline Stainless Steel
FLOOR	BS005	Artificial Stone
CEILING	CL 034	Hairline Stainless steel - Plexi
LIGHTING	LED AMPL	Led Bulb
HANDRAIL	BPB	Stainless Steel - Back I
MIRROR	TBRL	Full Length Grinding Laminated
STANDARD		EN 81-20 • EN 81-70



VAN GOGH



TEKNİK ÖZELLİKLER

YAN DUVAR	DJ005	Dijital Ahşap Kaplama
ARKA DUVAR	PSL001	Satine Paslanmaz
AKSEUAR	PSL001	Satine Paslanmaz
GÖNYE - BAŞLIK	PSL001	Satine Paslanmaz
TABAN	RAL5003	Boyalı Cam
TAVAN	CL 058	Satine Paslanmaz - Pleksi
AYDINLATMA	LS	Led Spot
KÜPEŞTE	BPB	Paslanmaz - Arka I
AYNA	TBRL	Tam Boy Rodajlı Lamine
STANDART	EN 81-20 • EN 81-70	

TECHNICAL SPECIFICATIONS

SIDE WALL	DJ005	Digital Printwood
BACK WALL	PSL001	Hairline Stainless Steel
ACCESSORY	PSL001	Hairline Stainless Steel
ENTRANCE SIDES & HEADER	PSL001	Hairline Stainless Steel
FLOOR	RAL5003	Painted Glass
CEILING	CL 058	Hairline Stainless Steel
LIGHTING	LS	Led Spot
HANDRAIL	BPB	Stainless Steel - Back I
MIRROR	TBRL	Full Length Grinding Laminated
STANDARD	EN 81-20 • EN 81-70	



Zemin ve aksesuarlar opsiyoneldir. Görsel temsilidir. Ürün teknik ve görsel açıdan farklılık gösterebilir.
Floor and accessories are optional. The product image is representative. The actual product may vary technically or visually from the image.

BARBAROS



TEKNİK ÖZELLİKLER

KAPLAMA I	SB013	Suni Deri Chester Kaplama
KAPLAMA II	SB013	Suni Deri Chester Kaplama
AKSEUAR	DM-01	Dekoratif Paslanmaz
GÖNYE - BAŞLIK	DM-01	Dekoratif Paslanmaz
TABAN	BS 033	Doğal Taş
TAVAN	CL 058	DM-01 Dekoratif Paslanmaz
AYDINLATMA	LS	Led Spot
KÜPEŞTE	BPB	Paslanmaz - Arka I
AYNA	YBRL	Yarım Boy Rodajlı Lamine
STANDART	-	

TECHNICAL SPECIFICATIONS

COATING I	SB013	Chesterfield Coating
COATING II	SB013	Chesterfield Coating
ACCESSORY	DM-01	Decorative Stainless Steel
ENTRANCE SIDES & HEADER	DM-01	Decorative Stainless Steel
FLOOR	BS 033	Real Stone
CEILING	CL 058	DM-01 Decorative Stainless Steel
LIGHTING	LS	Led Spot
HANDRAIL	BPB	Stainless Steel - Back I
MIRROR	YBRL	Half Length Grinding Laminated
STANDARD	-	



HAYYAM



TEKNİK ÖZELLİKLER

KAPLAMA I	IF001	Hayyam Yıldızlı Kaplama
KAPLAMA II	IF001	Hayyam Yıldızlı Kaplama
AKSEUAR	DG-01	Dekoratif Paslanmaz
GÖNYE - BAŞLIK	DG-01	Dekoratif Paslanmaz
TABAN	BS 024	Granit
TAVAN	CL 049	DG-01 Yıldızlı Kaplama
AYDINLATMA	AVİZE	Avize
KÜPEŞTE	-	
AYNA	Özel	
STANDART	-	

TECHNICAL SPECIFICATIONS

COATING I	IF001	Hayyam Gilded Coating
COATING II	IF001	Hayyam Gilded Coating
ACCESSORY	DG-01	Decorative Stainless Steel
ENTRANCE SIDES & HEADER	DG-01	Decorative Stainless Steel
FLOOR	BS024	Granite
CEILING	CL 049	DG-01 Gilded Coating
LIGHTING	AVİZE	Chandelier
HANDRAIL	-	
MIRROR	Special	
STANDARD	-	



Zemin ve aksesuarlar opsiyoneldir. Görsel temsilidir. Ürün teknik ve görsel açıdan farklılık gösterebilir.
Floor and accessories are optional. The product image is representative. The actual product may vary technically or visually from the image.

BİRÜNİ



TEKNİK ÖZELLİKLER

KAPLAMA I	LMH11	Laminant
KAPLAMA II	RAL9016	Lake Boyalı
AKSEUAR	DR-01	Dekoratif Paslanmaz
GÖNYE - BAŞLIK	DR-01	Dekoratif Paslanmaz
TABAN	BS 040	Kompoze Taş Smyrna
TAVAN	CL 045	DR-01 Dekoratif Paslanmaz
AYDINLATMA	LS	Led Spot
KÜPEŞTE	BPB	Paslanmaz
AYNA	Özel	
STANDART	-	

TECHNICAL SPECIFICATIONS

COATING SW	LMH11	Laminate
COATING BW	RAL9016	Lake Painted
ACCESSORY	DR-01	Decorative Stainless Steel
ENTRANCE SIDES & HEADER	DR-01	Decorative Stainless Steel
FLOOR	BS 040	Artificial Stone Smyrna
CEILING	CL 045	DR-01 Decorative Stainless Steel
LIGHTING	LS	Led Spot
HANDRAIL	BPB	Stainless Steel
MIRROR	Special	
STANDARD	-	



HİPOKRAT

HASTANE | HOSPITAL



TEKNİK ÖZELLİKLER

YAN DUVAR	PSL001	Satine Paslanmaz
ARKA DUVAR	PSL001	Satine Paslanmaz
AKSESUAR	PSL001	Satine Paslanmaz
GÖNYE - BAŞLIK	PSL001	Satine Paslanmaz
TABAN	PVC 008	PVC Siyah
TAVAN	CL 036	Satine Paslanmaz
AYDINLATMA	LED AMPL	Led Ampül
KÜPEŞTE	BPB-K	Paslanmaz - Arka 1
AYNA	YBRL	Yarım Boy Rodajlı Lamine
STANDART		EN 81-20 • EN 81-70

TECHNICAL SPECIFICATIONS

SIDE WALL	PSL001	Hairline Stainless Steel
BACK WALL	PSL001	Hairline Stainless Steel
ACCESSORY	PSL001	Hairline Stainless Steel
ENTRANCE SIDES & HEADER	PSL001	Hairline Stainless Steel
FLOOR	PVC 008	PVC Black
CEILING	CL 036	Hairline Stainless Steel
LIGHTING	LED AMPL	Led Bulb
HANDRAIL	BPB-K	Stainless Steel - Back 1
MIRROR	YBRL	Half Length Grinding Laminated
STANDARD		EN 81-20 • EN 81-70



Zemin ve aksesuarlar opsiyoneldir. Görsel temsildir. Ürün teknik ve görsel açıdan farklılık gösterebilir.
Floor and accessories are optional. The product image is representative. The actual product may vary technically or visually from the image.

HERCULES

AĞIR YÜK | HEAVY WEIGHT

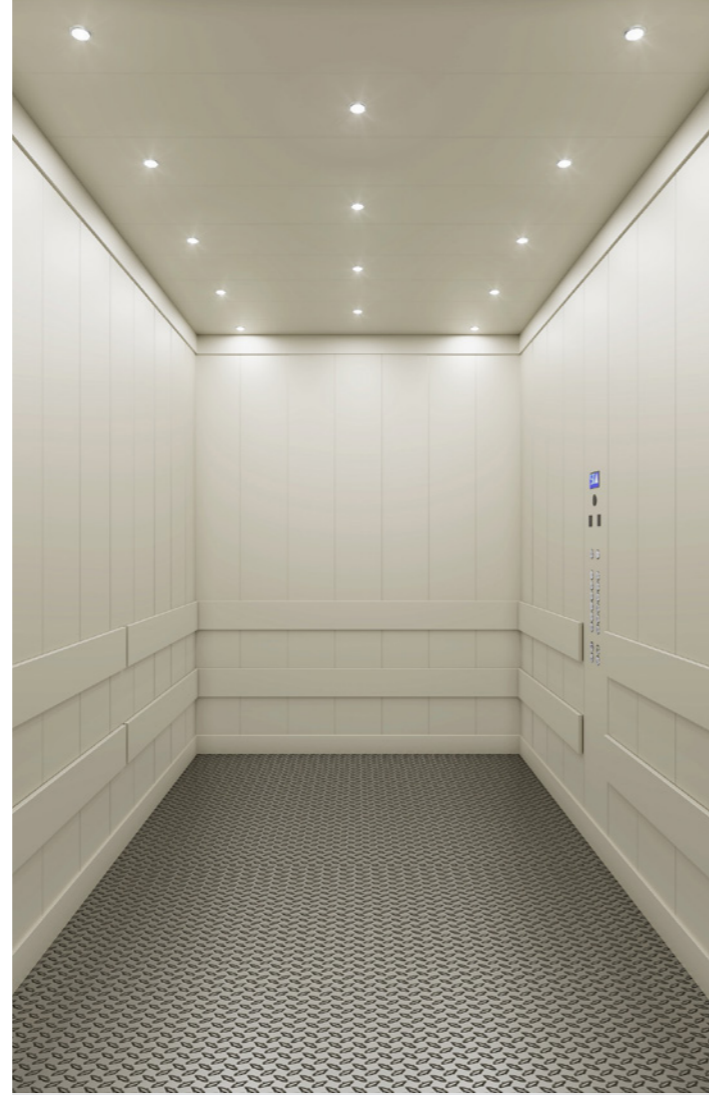

TEKNİK ÖZELLİKLER

YAN DUVAR	RAL7032	Elektrostatik Boya
ARKA DUVAR	RAL7032	Elektrostatik Boya
AKSESUAR	RAL7032	Elektrostatik Boya
GÖNYE - BAŞLIK	RAL7032	Elektrostatik Boya
TABAN	BS 028	Gözyaşı Desenli Sac
TAVAN	RAL7032	Elektrostatik Boya
AYDINLATMA	LS	Led Spot
KÜPEŞTE	-	-
AYNA	-	-
STANDART		EN 81-20 • EN 81-70 (Opsiyonel)

TECHNICAL SPECIFICATIONS

SIDE WALL	RAL7032	Electrostatic Painted
BACK WALL	RAL7032	Electrostatic Painted
ACCESSORY	RAL7032	Electrostatic Painted
ENTRANCE SIDES & HEADER	RAL7032	Hairline Stainless Steel
FLOOR	BS 028	Checkered Plate
CEILING	RAL7032	Electrostatic Painted
LIGHTING	LS	Led Spot
HANDRAIL	-	-
MIRROR	-	-
STANDARD		EN 81-20 • EN 81-70 (Optional)



ANTI-VANDAL



TEKNİK ÖZELLİKLER

YAN DUVAR	PSL011	Düz Kare Paslanmaz
ARKA DUVAR	PSL011	Düz Kare Paslanmaz
AKSESUAR	PSL011	Düz Kare Paslanmaz
GÖNYE - BAŞLIK	PSL011	Düz Kare Paslanmaz
TABAN	BS 032	Alüminyum Çeta
TAVAN	CL 034	Düz Kare Paslanmaz - Lamine Cam - Pleksi
AYDINLATMA	LED AMPL	Led Ampül
KÜPEŞTE	BPB-K	Paslanmaz - Arka 1 + Yan Duvarlar
AYNA	DM-01	Dekoratif Paslanmaz
STANDART		EN 81-20 • EN 81-70 • EN 81-71

TECHNICAL SPECIFICATIONS

SIDE WALL	PSL011	Flat-Square Stainless Steel
BACK WALL	PSL011	Flat-Square Stainless Steel
ACCESSORY	PSL011	Flat-Square Stainless Steel
ENTRANCE SIDES & HEADER	PSL001	Hairline Stainless Steel
FLOOR	BS 032	Aluminium Checker Plate
CEILING	CL 034	Flat-Square Stainless Steel - Laminated Glass - Plexi
LIGHTING	LED AMPL	Led Bulb
HANDRAIL	BPB-K	Stainless Steel - Back 1 + Side Walls
MIRROR	DM-01	Decorative Stainless Steel
STANDARD		EN 81-20 • EN 81-70 • EN 81-71



Zemin ve aksesuarlar opsiyoneldir. Görsel temsildir. Ürün teknik ve görsel açıdan farklılık gösterebilir.
Floor and accessories are optional. The product image is representative. The actual product may vary technically or visually from the image.

ACİL DURUM

EMERGENCY



TEKNİK ÖZELLİKLER

YAN DUVAR	PSL001	Satine Paslanmaz
ARKA DUVAR	PSL001	Satine Paslanmaz
AKSESUAR	PSL001	Satine Paslanmaz
GÖNYE - BAŞLIK	PSL001	Satine Paslanmaz
TABAN	BS 032	Alüminyum Çeta
TAVAN	CL 034	Satine Paslanmaz
AYDINLATMA	LS	Led Spot
KÜPEŞTE	BPB-K	Paslanmaz - Yan 1
AYNA	YBRL	Yarım Boy Rodajlı Lamine
STANDART		EN 81-20 • EN 81-70 • EN 81-72

TECHNICAL SPECIFICATIONS

SIDE WALL	PSL001	Hairline Stainless Steel
BACK WALL	PSL001	Hairline Stainless Steel
ACCESSORY	PSL001	Hairline Stainless Steel
ENTRANCE SIDES & HEADER	PSL001	Hairline Stainless Steel
FLOOR	BS 032	Aluminium Checker Plate
CEILING	CL 034	Hairline Stainless Steel
LIGHTING	LED AMPL	Led Bulb
HANDRAIL	BPB-K	Stainless Steel - Side 1
MIRROR	YBRL	Half Length Grinding Laminated
STANDARD		EN 81-20 • EN 81-70 • EN 81-72



BATTUTA

PANORAMİK KABİN | PANORAMIC CABIN

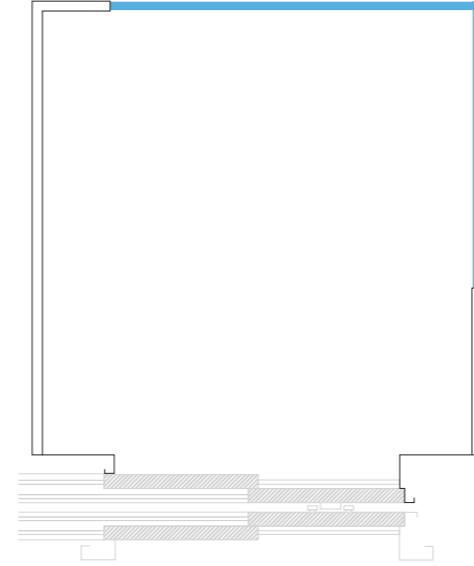

TEKNİK ÖZELLİKLER

KAPLAMA	PSL001	Satine Paslanmaz
AKSESUAR	DM-01	Dekoratif Paslanmaz
GÖNYE - BAŞLIK	PSL001	Satine Paslanmaz
TABAN	BS 044	Kompoze Taş Nepilia
TAVAN	PSL001	Satine Paslanmaz
AYDINLATMA	LS	Led Spot
KÜPEŞTE	BPB	Paslanmaz
STANDART		EN 81-20 • EN 81-70

TECHNICAL SPECIFICATIONS

COATING	PSL001	Hairline Stainless Steel
ACCESSORY	DM-01	Decorative Stainless Steel
ENTRANCE SIDES & HEADER	DM-01	Hairline Stainless Steel
FLOOR	BS 044	Artificial Stone Nepilia
CEILING	PSL001	Hairline Stainless Steel
LIGHTING	LS	Led Spot
HANDRAIL	BPB	Stainless Steel
STANDARD		EN 81-20 • EN 81-70

PLATON

PANORAMİK KABİN | PANORAMIC CABIN

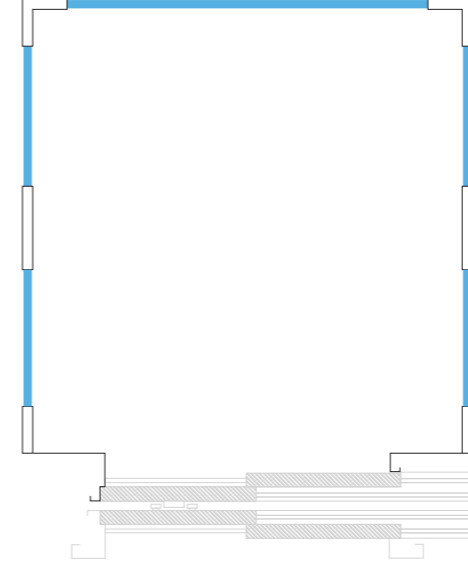

TEKNİK ÖZELLİKLER

KAPLAMA	PSL001	Satine Paslanmaz
AKSESUAR	PSL001	Satine Paslanmaz
GÖNYE - BAŞLIK	PSL001	Satine Paslanmaz
TABAN	BS 040	Kompoze Taş Smyrna
TAVAN	PSL001	Satine Paslanmaz
AYDINLATMA	LS	Led Spot
KÜPEŞTE	BPB	Paslanmaz
STANDART		EN 81-20 • EN 81-70

TECHNICAL SPECIFICATIONS

COATING	PSL001	Hairline Stainless Steel
ACCESSORY	PSL001	Hairline Stainless Steel
ENTRANCE SIDES & HEADER	PSL001	Hairline Stainless Steel
FLOOR	BS 040	Artificial Stone Symma
CEILING	PSL001	Hairline Stainless Steel
LIGHTING	LS	Led Spot
HANDRAIL	BPB	Stainless Steel
STANDARD		EN 81-20 • EN 81-70



Zemin ve aksesuarlar opsiyoneldir. Görsel temsilidir. Ürün teknik ve görsel açıdan farklılık gösterebilir.
Floor and accessories are optional. The product image is representative. The actual product may vary technically or visually from the image.



Zemin ve aksesuarlar opsiyoneldir. Görsel temsilidir. Ürün teknik ve görsel açıdan farklılık gösterebilir.
Floor and accessories are optional. The product image is representative. The actual product may vary technically or visually from the image.

PASCAL

PANORAMİK KABİN | PANORAMIC CABIN

PİRİ REİS

PANORAMİK KABİN | PANORAMIC CABIN

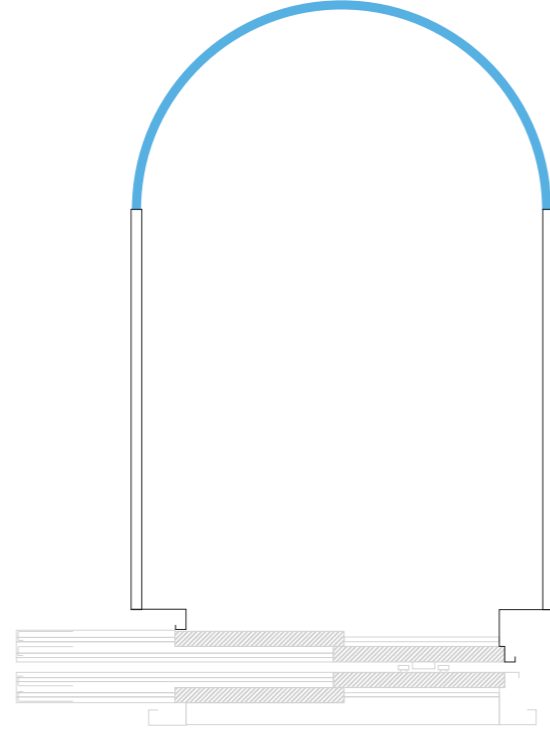

TEKNİK ÖZELLİKLER

KAPLAMA	PSL001	Satine Paslanmaz
AKSESUAR İÇ	DM-01	Dekoratif Paslanmaz
AKSESUAR DIŞ	DM-01	Dekoratif Paslanmaz (Opsiyonel)
GÖNYE - BAŞLIK	PSL001	Satine Paslanmaz
TABAN	BS 017	Doğal Taş
TAVAN	DM-01	Dekoratif Paslanmaz
AYDINLATMA	LS	Led Spot
KÜPEŞTE	BPB	Paslanmaz
STANDART		EN 81-20 • EN 81-70

TECHNICAL SPECIFICATIONS

COATING	PSL001	Hairline Stainless Steel
ACCESSORY INTERIOR	DM-01	Decorative Stainless Steel
ACCESSORY EXTERIOR	DM-01	Decorative Stainless Steel (Optional)
ENTRANCE SIDES & HEADER	PSL001	Hairline Stainless Steel
FLOOR	BS 017	Real Stone
CEILING	DM-01	Decorative Stainless Steel
LIGHTING	LS	Led Spot
HANDRAIL	BPB	Stainless Steel
STANDARD		EN 81-20 • EN 81-70

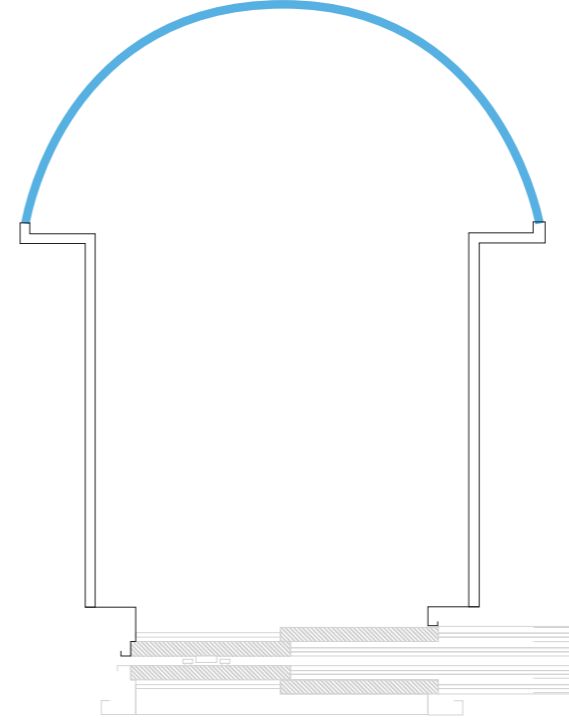

TEKNİK ÖZELLİKLER

KAPLAMA	PSL001	Satine Paslanmaz
AKSESUAR İÇ	DM-01	Dekoratif Paslanmaz
AKSESUAR DIŞ	DG-01	Dekoratif Paslanmaz (Opsiyonel)
GÖNYE - BAŞLIK	PSL001	Satine Paslanmaz
TABAN	BS 017	Doğal Taş
TAVAN	DM-01	Dekoratif Paslanmaz
AYDINLATMA	LS	Led Spot
KÜPEŞTE	BPB	Paslanmaz
STANDART		EN 81-20 • EN 81-70

TECHNICAL SPECIFICATIONS

COATING	PSL001	Hairline Stainless Steel
ACCESSORY INTERIOR	DM-01	Decorative Stainless Steel
ACCESSORY EXTERIOR	DG-01	Decorative Stainless Steel (Optional)
ENTRANCE SIDES & HEADER	PSL001	Hairline Stainless Steel
FLOOR	BS 017	Real Stone
CEILING	DM-01	Decorative Stainless Steel
LIGHTING	LS	Led Spot
HANDRAIL	BPB	Stainless Steel
STANDARD		EN 81-20 • EN 81-70



Zemin ve aksesuarlar opsiyoneldir. Görsel temsildir. Ürün teknik ve görsel açıdan farklılık gösterebilir.
Floor and accessories are optional. The product image is representative. The actual product may vary technically or visually from the image.

Zemin ve aksesuarlar opsiyoneldir. Görsel temsildir. Ürün teknik ve görsel açıdan farklılık gösterebilir.
Floor and accessories are optional. The product image is representative. The actual product may vary technically or visually from the image.

KARKAS TIPLERİ | CARCASS TYPE

ELEKTRİK KABİN KARKASLARI | ELECTRIC CABIN CARCASS

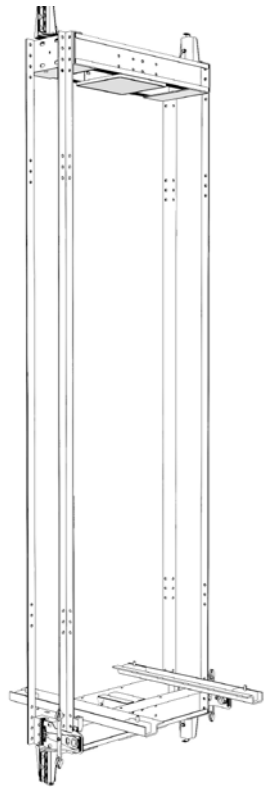

1/1 KARKAS - S01
1/1 CARCASS - S01

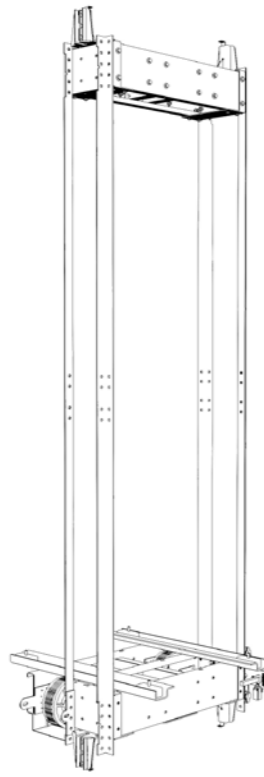

2/1 KARKAS - S30
2/1 CARCASS - S30

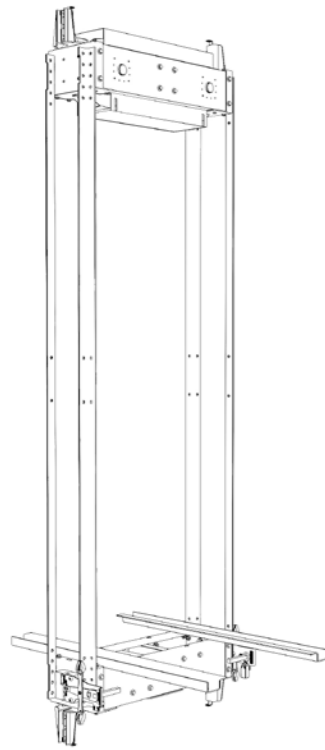

2/1 KARKAS - S20
2/1 CARCASS - S20

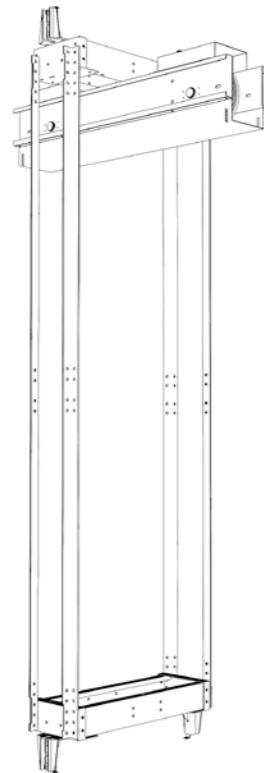

2/1 KARKAS - S21
2/1 CARCASS - S21

L KABİN KARKASLAR | L CABIN CARCASS



1/1 KARKAS - SL45
1/1 CARCASS - SL45

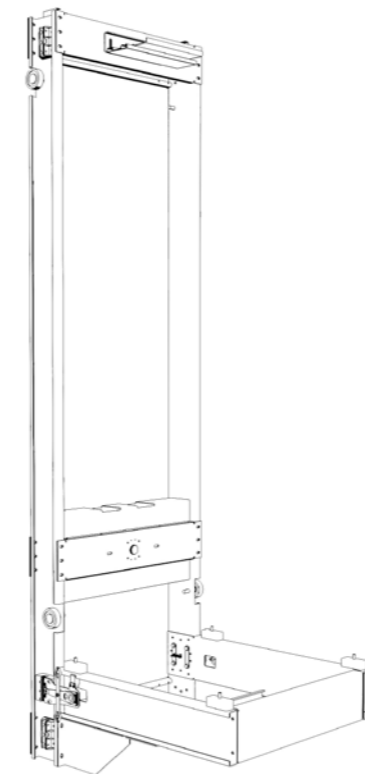

2/1 KARKAS - SL46
2/1 CARCASS - SL46

KARKAS TIPLERİ | CARCASS TYPE

AĞIRLIK KARKASLARI | COUNTERWEIGHT CARCASS



1/1 KARKAS - H01
1/1 CARCASS - H01

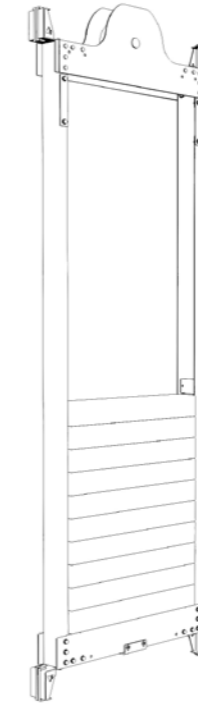

2/1 KARKAS - H10
2/1 CARCASS - H10



2/1 KARKAS - H20
2/1 CARCASS - H20



2/1 KARKAS - H21
2/1 CARCASS - H21

MAKİNE KARKASLARI | MACHINE CARCASS

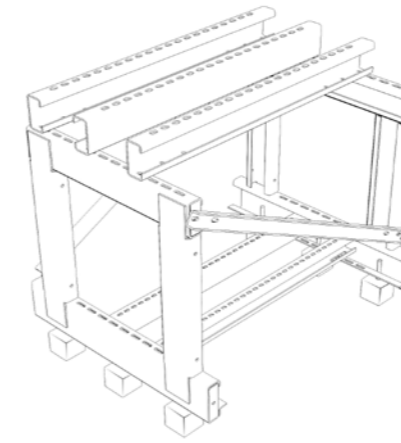

MS11

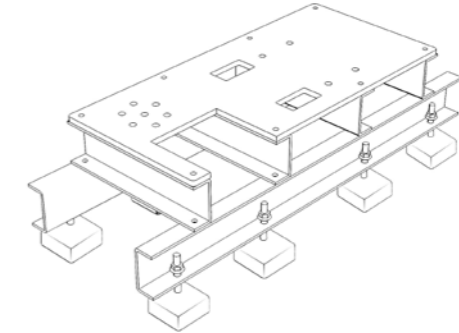

MS12

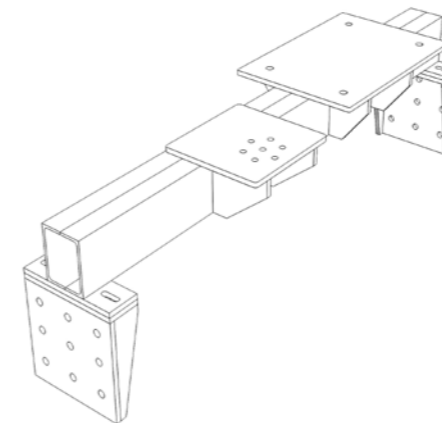

MS21

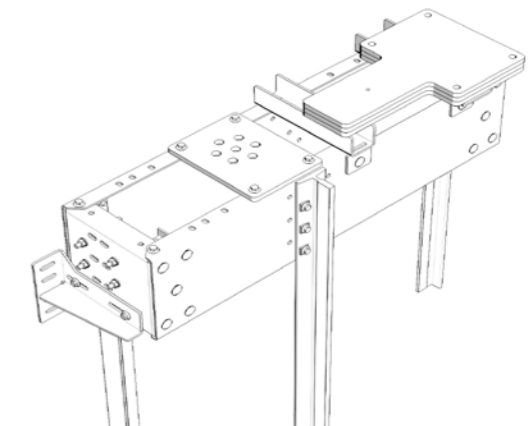

MS22

Zemin ve aksesuarlar opsiyoneldir. Görsel temsilidir. Ürün teknik ve görsel açıdan farklılık gösterebilir.
Floor and accessories are optional. The product image is representative. The actual product may vary technically or visually from the image.

Zemin ve aksesuarlar opsiyoneldir. Görsel temsilidir. Ürün teknik ve görsel açıdan farklılık gösterebilir.
Floor and accessories are optional. The product image is representative. The actual product may vary technically or visually from the image.

SERVİS ASANSÖRÜ DUMBWAITER

**KUSURSUZ SERVİS
TECRÜBE İSTER
PERFECT SERVICE
REQUIRES EXPERIENCE**



SERVİS ASANSÖRÜ DUMBWAITER

KABİN KAPLAMA | CABIN COATING

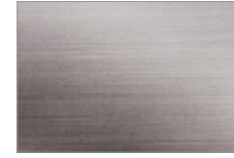

PSL 001
Satine Paslanmaz
Hairline Stainless Steel

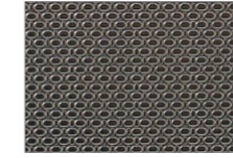

PSL 010
Nokta Paslanmaz
Linen Stainless Steel

KAT KAPILARI | LANDING DOORS



Giyotin Kapı | Guillotine Door



Çarpma Kapı | Swing Door

TEKNİK ÖZELLİKLER

Kapasite	50 - 250
Maksimum Durak Sayısı	8
Maksimum Seyahat Mesafesi (m)	25
Motor	Tamburlu & Karşı Ağırlıklı
Konstrüksiyon	Galvanizli & Ral Boyalı

KABİN

Satine Paslanmaz	Çıkarılabilir Orta Raf	Tek veya Çift Giriş 180°
------------------	------------------------	--------------------------

KAT KAPILARI

GIYOTİN KAPI	ÇARPMA KAPI
Satine Paslanmaz Net Giriş Açıklığı : 500 - 1000mm Net Giriş Yüksekliği : 500 - 1000mm	Satine Paslanmaz Net Giriş Açıklığı : 600 - 1000mm Net Giriş Yüksekliği : 1000 - 1200mm

TECHNICAL SPECIFICATIONS

Capacity	50 - 250 kg
Maximum Stop Quantity	8
Maximum Travel Distance (m)	125
Machine	Drummed or Counterweighted
Konstrüksiyon	Galvanized Steel Structure

CAR

Finished in Stainless Steel	Removable Mid-Shelf	Single or Double Entrance 180°
-----------------------------	---------------------	--------------------------------

LANDING DOORS

GIYOTINE DOOR	SWING DOOR
Finished in Stainless Steel Clear Entrance Opening : 500 - 1000mm Clear Entrance Height : 500 - 1000mm	Hairline Stainless Steel Clear Entrance Opening : 600 - 1000mm Clear Entrance Height : 1000 - 1200mm



P.A.C

KABİNLER İÇİN HAVA TEMİZLEME ÜNİTESİ
PURIFYING AIR FOR CABINS

PAC İLE ASANSÖRÜNÜZÜN HAVASINI DEĞİŞTİRİN.
IMPROVE AIR QUALITY OF YOUR LIFTS WITH PAC.

Asansör kabini içindeki havada biriken bakteri, virüs ve mantar gibi mikroorganizmaların temizler, kötü ve rahatsız edici kokuları yok eder.

This unit cleans such harmful microorganisms as bacteria, viruses and fungus in the air and removes bad smells.

- Çok Katmanlı Filtre Yapısı
- Maksimum 55W Güç Tüketimi
- Maksimum Ağırlık 6 kg
- Ayarlanabilir Kademeli Fan Hızı
- Kompakt tasarımı ile mevcut asansör kabinine uygulanabilme
- Multi-Layered Filter Structure
- Maximum 55W Power Consumption
- 6 kg Weight
- Adjustable Gradual Fan Speed
- Can be applied easily in cabin due to compact design



P.A.C

KABİNLER İÇİN HAVA TEMİZLEME ÜNİTESİ
PURIFYING AIR FOR CABINS

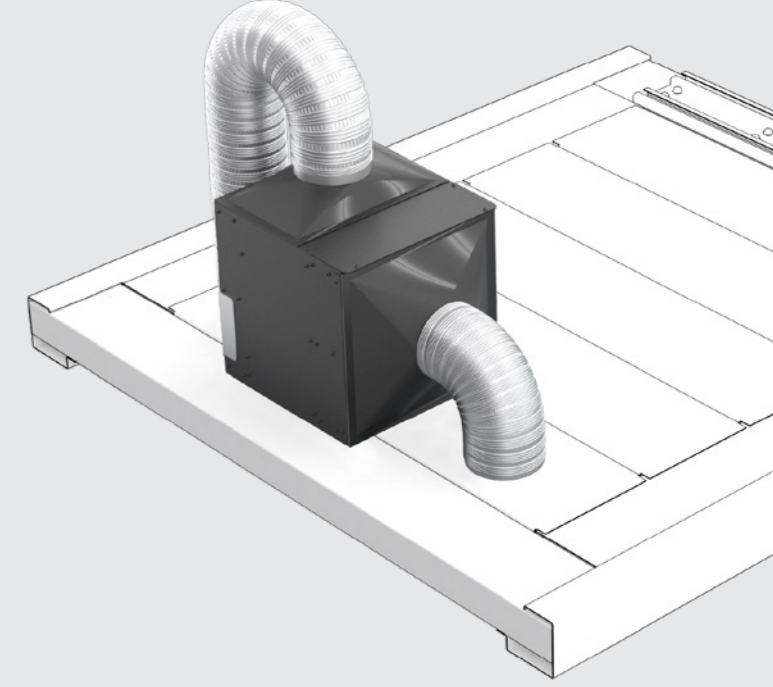

150 $\frac{m^3}{sa}$
HAVA TEMİZLEME
KAPASİTESİ
AIR CLEANING CAPACITY

99,50%
ZARARLI ORGANİZMA
TEMİZLEME ORANI
AIR CLEANING RATE

UV KATALİZÖRLÜ
TEMİZLEYİCİ
CATALYST CLEANER

TEKNİK ÖZELLİKLER

FİLTRELER		
FİLTRE KARTUŞ İÇERİĞİ	HEPA SINIFI (EN 1822)	HEPA VERİMİ (≥0.3 µm)
Kaba Filtre, Hepa Filtre	H13	%99,95
HEPA ÖN BASINÇ DÜŞÜŞÜ	HEPA HAVA AKIŞ HIZI	
100 Pa	0-150 m³/sa	

SES SEVİYESİ	
MİNİMUM	MAKSİMUM
25 dB	47 dB

UV LAMBA		
DALGA BOYU [nm]	UZUNLUK [mm]	GÜÇ
253,7 (UVC)	29,3	8 W, 220V, 50 Hz

BOYUTLAR		
475x315x330 mm	AĞIRLIK	GÜÇ KAYNAĞI
	6 Kg	230±10V, 55Watt

TECHNICAL SPECIFICATIONS

FİLTRES		
FİLTRE KARTUŞ SUBSTANS	HEPA CLASS (EN 1822)	HEPA CAPACITY (≥0.3 µm)
Coarse Filter, Hepa Filter	H13	%99,95
HEPA INITIAL PRESSURE DECLINE	HEPA AIRFLOW VELOCITY	
100 Pa	0-150 m³/sa	

SOUND LEVEL	
MİNİMUM	MAXİMUM
25 dB	47 dB

UV LIGHT		
WAVE LENGTH [nm]	LENGTH [mm]	POWER
253,7 (UVC)	29,3	8 W, 220V, 50 Hz

DIMENSIONS		
475x315x330 mm	WEIGHT	POWER SUPPLY
	6 Kg	230±10V, 55Watt

OPSİYONLAR OPTIONS

KAPLAMA | COATING

RAL RENKLERİ | RAL COLORS

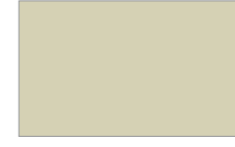

RAL 7032

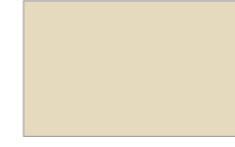

RAL 1013



RAL 1019



RAL 8008

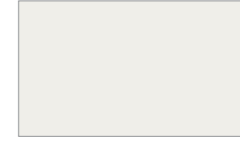

RAL 9003



RAL 5012



RAL 5015



RAL 5024

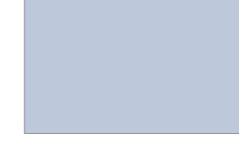

RAL 170-3

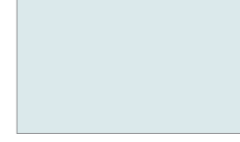

RAL 180-6

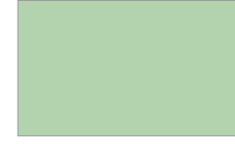

RAL 6019

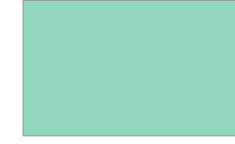

RAL 6027

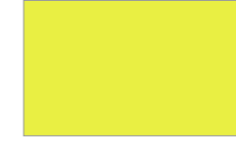

RAL 1016

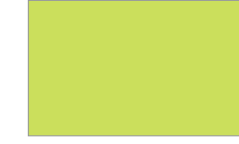

RAL 6019

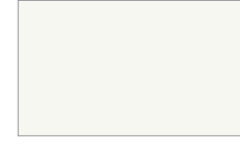

RAL 9016



RAL 7001



RAL 5014



RAL 9005



RAL 9006



RAL 9007

AHŞAP | WOOD EN.81.20



M11470

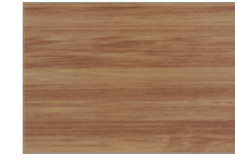

M13467



M13452



M14570

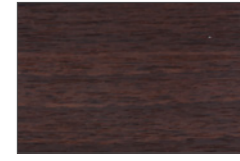

M14945



M14350



M19790



M2308-01



M2702



M8822-1



M8814-1



M8814-2



M91322



M53001



M5433



M3003



M3001

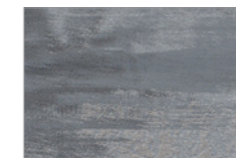

M12305



M12308

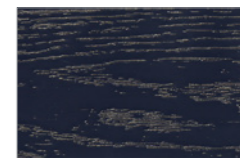

M4201

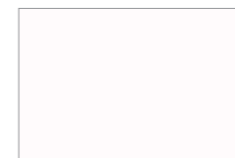

MSM233



MHG246

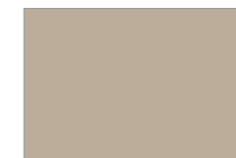

MHG00557



MHG00554



MHG00440

KAPLAMA | COATING

PASLANMAZLAR | STAINLESS STEEL



PSL 001
Satine Paslanmaz
Hairline Stainless Steel



PSL 010
Nokta Paslanmaz
Linen Stainless Steel



PSL 011
Düz Kare Paslanmaz
Flat-Square Stainless Steel



PSL 012
Çapraz Kare Paslanmaz
Cross-Square Stainless Steel



PSL 013
Deri Paslanmaz
Leather Stainless Steel

DEKORATİF PASLANMAZLAR | DECORATIVE STAINLESS STEEL

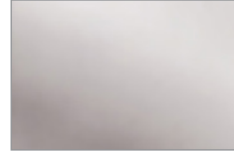

DM 01



DM 02



DM 04

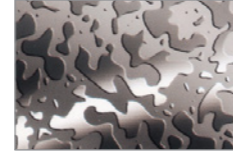

DM 05

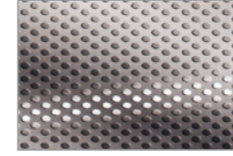

DM 09



DM 11

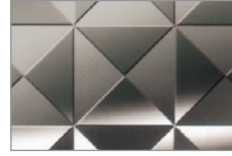

DM 13



DM 15

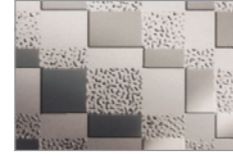

DM 17



DM 21



DM 23

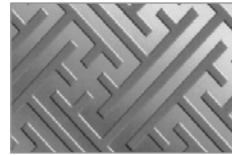

DM 26



DG 01



DG 05



DG 06



DG 10



DG 21

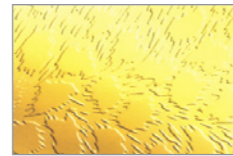

DG 25



DG 26



DB - SB

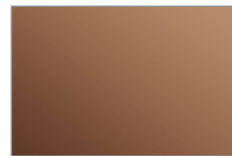

DR 01

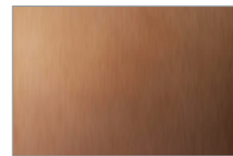

DR - SB



DM-V

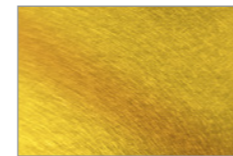

DG-V

KÜPEŞTELER | HANDRAILS



BPB



BPB-K



SPB



SPB-K

Görsel temsildir. Baskıdan kaynaklı farklılıklar gösterebilir.
The product image is representative. The actual product may vary printing from the image.

KAPLAMA | COATING

VAN GOGH - DİJİTAL AHŞAP | DIGITAL PRINTWOOD



DJ 002

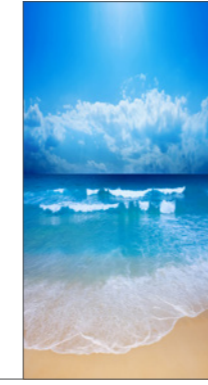

DJ 003



DJ 004



DJ 005

Duvar | Wall



RAL 5011 BOYALI CAM
PAINTED GLASS



BS 035 DİJİTAL BASKILI CAM
DIGITAL PRINT GLASS



RAL 3009 BOYALI CAM
PAINTED GLASS



RAL 5003 BOYALI CAM
PAINTED GLASS

Taban | Floor

PICASSO - BOYALI CAM | PAINTED GLASS



GL 007

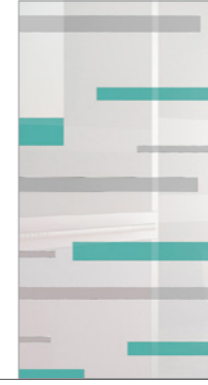

GL 008



GL 009



GL 010

Duvar | Wall



RAL 9003 BOYALI CAM | PAINTED GLASS



RAL 9005 BOYALI CAM | PAINTED GLASS

Taban | Floor

AYNALAR | MIRRORS

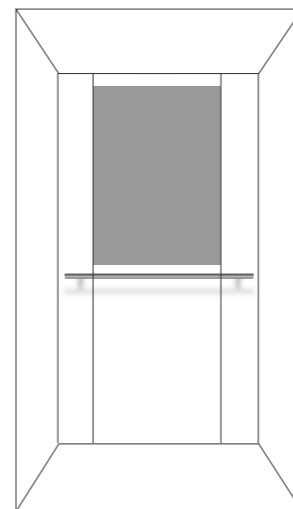

YARIM BOY RODAJLI LAMİNE (YBRL)
HALF LENGHT GRINDING LAMINATED

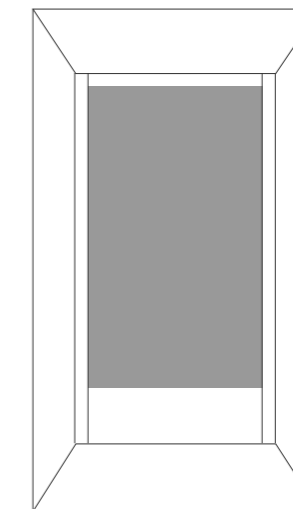
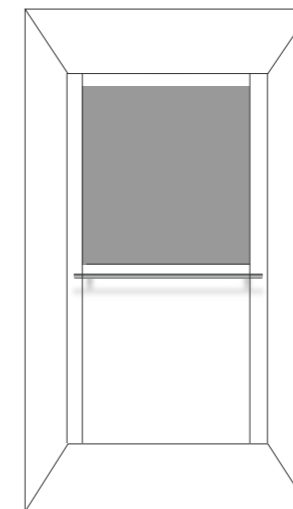

TAM BOY RODAJLI LAMİNE (TBRL)
FULL LENGHT GRINDING LAMINATED

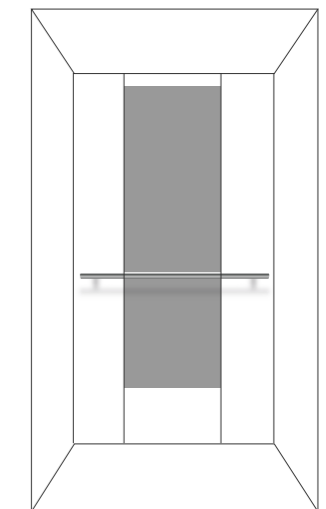

TABAN | FLOOR

DOĞAL TAŞ | REAL STONE

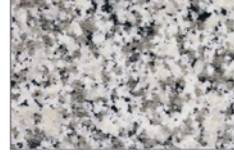

BS 008 BIANCO PERLA



BS 009 BLUE PEARL

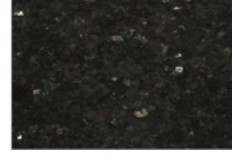

BS 010 EMERALD PEARL



BS 011 BIANCO NURBLADO

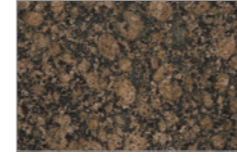

BS 013 BALTIC BROWN

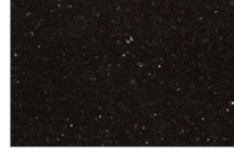

BS 014 STAR GALAXY

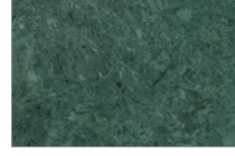

BS 015 VERDE GUETAMALA

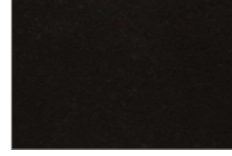

BS 017 NERO ZIMBABWE

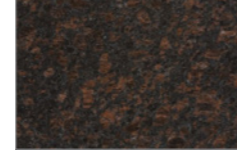

BS 017 TAN BROWN

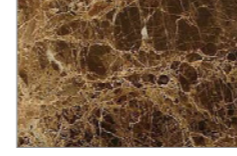

BS 030 EMPREDOR DARK

KOMPOZE TAŞ | ARTIFICIAL STONE

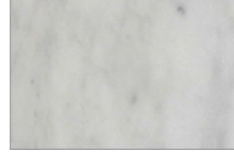

BS 005

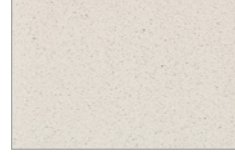

BS 016 ARCADIA



BS 036 LAPAZ

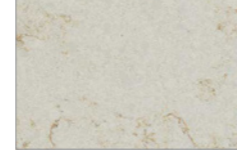

BS 037 LEBEDOS



BS 010 SAVANA

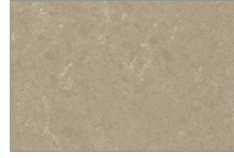

BS 040 SMYRNA

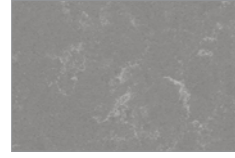

BS 041 TUNDRA

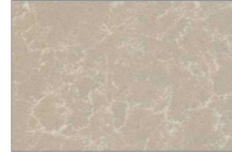

BS 042 LINEN

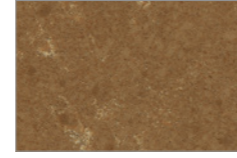

BS 043 TROAS



BS 044 NEPIJA

BOYALI CAM | PAINTED GLASS



BS 035

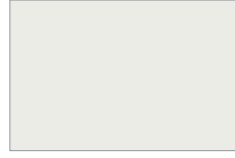

RAL 9003



RAL 9005



RAL 5003



RAL 5011



RAL 6034



RAL 7036



RAL 7038



RAL 3009



RAL 3020

PVC | PVC

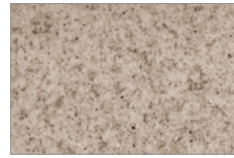

PVC 001

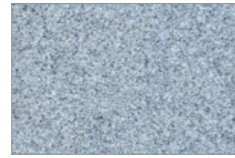

PVC 002

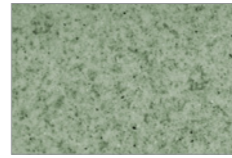

PVC 003



PVC 005

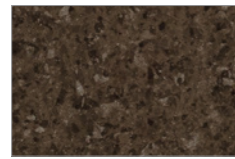

PVC 007

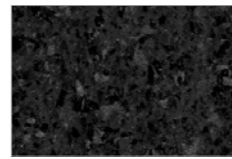

PVC 008

DİĞER | OTHER

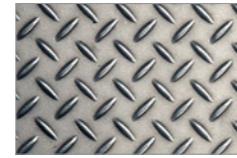

BS 028
Gözyaşı Desenli Sac
Checkered Plate

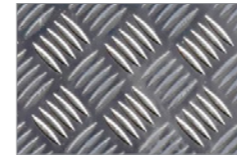

BS 032
Alüminyum
Aluminium

TAVAN | CEILING



CL 009

Dekoratif Paslanmaz | Decorative Stainless Steel
Satine Paslanmaz | Hairline Stainless Steel
Led Ampül | Led Bulb



CL 027

Dekoratif Paslanmaz | Decorative Stainless Steel
Satine Paslanmaz | Hairline Stainless Steel
Led Ampül | Led Bulb



CL 034

Dekoratif Paslanmaz | Decorative Stainless Steel
Satine Paslanmaz | Hairline Stainless Steel
RAL9003 Boyalı | RAL9003 Painted
Led Ampül | Led Bulb
Led Panel | Led Panel



CL 036

Dekoratif Paslanmaz | Decorative Stainless Steel
Satine Paslanmaz | Hairline Stainless Steel
Led Ampül | Led Bulb



CL 043

Dekoratif Paslanmaz | Decorative Stainless Steel
Satine Paslanmaz | Hairline Stainless Steel
Led Spot | Led Spot



CL 044

Dekoratif Paslanmaz | Decorative Stainless Steel
Satine Paslanmaz | Hairline Stainless Steel
Led Spot | Led Spot



CL 045

Dekoratif Paslanmaz | Decorative Stainless Steel
Satine Paslanmaz | Hairline Stainless Steel
Led Spot | Led Spot



CL 050

Dekoratif Paslanmaz | Decorative Stainless Steel
Satine Paslanmaz | Hairline Stainless Steel
Led Spot | Led Spot



CL 051

Dekoratif Paslanmaz | Decorative Stainless Steel
Satine Paslanmaz | Hairline Stainless Steel
RAL9003 Boyalı | RAL9003 Painted
Led Ampül | Led Bulb
Led Panel | Led Panel



CL 053

Dekoratif Paslanmaz | Decorative Stainless Steel
Satine Paslanmaz | Hairline Stainless Steel
Led Ampül | Led Bulb
Led Panel | Led Panel



CL 056

Dekoratif Paslanmaz | Decorative Stainless Steel
Satine Paslanmaz | Hairline Stainless Steel
Led Ampül | Led Bulb



CL 057

Dekoratif Paslanmaz | Decorative Stainless Steel
Satine Paslanmaz | Hairline Stainless Steel
Led Ampül | Led Bulb
Led Panel | Led Panel



CL 058

Dekoratif Paslanmaz | Decorative Stainless Steel
Satine Paslanmaz | Hairline Stainless Steel
RAL9003 Boyalı | RAL9003 Painted
Led Spot | Led Spot



CL 059

Dekoratif Paslanmaz | Decorative Stainless Steel
Satine Paslanmaz | Hairline Stainless Steel
Led Ampül-Led Spot | Led Bulb-Led Spot



CL 060

Dekoratif Paslanmaz | Decorative Stainless Steel
Satine Paslanmaz | Hairline Stainless Steel
Led Ampül | Led Bulb

Görsel temsildir. Baskıdan kaynaklı farklılıklar gösterebilir.
The product image is representative. The actual product may vary printing from the image.

Zemin ve aksesuarlar opsiyoneldir. Görsel temsildir. Ürün teknik ve görsel açıdan farklılık gösterebilir.
Floor and accessories are optional. The product image is representative. The actual product may vary technically or visually from the image.

SERTİFİKALAR | CERTIFICATES

MARKA TESCİL | BRAND REGISTRY



Merih Asansör 2005



Merih Asansör 2016

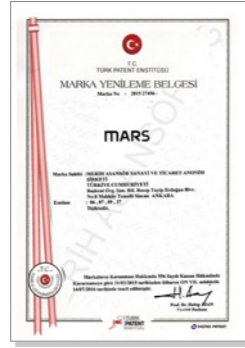

Mars (Türkiye) 2016



Mars (USA) 2016



Mars (EUIPO) 2016

YÖNETİM SİSTEMİ BELGELERİ | MANAGEMENT SYSTEM CERTIFICATES



ISO 9001:2015 - Merih 1



ISO 9001:2015 - Merih 2



ISO 9001:2015 - Mars

YERLİ MALİ BELGELERİ | DOMESTIC GOODS CERTIFICATES



Komple Asansör Sistemi
Complete Elevator System



Kat & Kabin Kapısı
Landing & Car Door



Giyotin Kapı | Guillotine Door



Kabin | Car



Servis Asansörü | Dumbwaiter

SERTİFİKALAR | CERTIFICATES

ÜRÜN UYGUNLUK BELGELERİ | PRODUCTS CONFORMITY DOCUMENTS



TSEK Kat & Kabin Kapısı
Landing & Car Doors



TSEK Kabin | Car



TURQUM
Turkish Quality of Machinery



Asansörler İçin AB Tip İncelemesi Sertifikası
EU Type Examination Certificate For Lifts

CE BELGELERİ | CE CERTIFICATES



Kabin Kapısı Kilit Sertifikası
Car Door Lock Certificate



B-01, B-20 Kilit Sertifikası
B-01, B-20 Lock Certificate



C-01 Kilit Sertifikası
C-01 Lock Certificate



H-MAX Kilit Sertifikası
H-MAX Lock Certificate



B-01/AV M2P EN 81-71
B-01/AV C2P EN 81-71



B-01/AV T2P EN 81-71



E-01 M2P/T2P EN 81-20
E-01 C2P/T2P EN 81-20



KLT 007 Kabin Kapısı Kilit Sertifikası
KLT 007 Car Door Lock Certificate

EAC BELGELERİ | EAC CERTIFICATES



B-01 Kilit Sertifikası
B-01 Lock Certificate



C-01 Kilit Sertifikası
C-01 Lock Certificate

GRUP ŞİRKETLER | GROUP COMPANIES

Merih, iki adet üretim tesisi, global marka değerine sahip ürünleriyle yurt içinde; Atik Asansör ve Altes Asansör aracılığıyla hizmet vermektedir. Merih geniş ürün yelpazesi, yüksek ürün güvenilirliği ve kalitesiyle dünyada 5 kıtada 65 ülkeye Mars Elevator markası ile Komple Asansör Sistemleri satışı yapmaktadır.

With two production facilities and global brand value products, Merih render service through Atik Asansör and Altes Asansör in Turkey. With its wide product range, high product reliability and quality; Merih Asansör sells Complete Elevator Systems to more than 65 countries in 5 continents with Mars Elevator brand.



Atik Asansör, 1999 yılında Ankara'da Bölge Müdürlüğü olarak kurulmuştur. Merih Asansör'ün İç Anadolu, Akdeniz, Güneydoğu Anadolu, Doğu Anadolu ve Karadeniz Bölgelerine yurt içi satışları Atik Asansör aracılığıyla gerçekleştirilmektedir.

Atik Asansör was established in 1999 in Ankara as Regional Directorate of Merih Asansör Company. Atik Asansör is involved in domestic sales of Merih Asansör products in Central, Southern, Eastern Anatolia, Mediterranean and Black Sea regions.

Başkent OSB Recep Tayyip Erdoğan Bulvarı No: 8 Malıköy - Sincan/ANKARA
Tel: 0 312 395 23 41



2008 yılında İstanbul'da faaliyete başlayan Altes Asansör, Merih Asansör'ün Bölge Müdürlüğü olarak kurulmuştur. Merih Asansör'ün Ege ve Marmara bölgelerine yurt içi satışları Altes Asansör aracılığıyla gerçekleştirilmektedir.

Altes Asansör was established in 2008 in İstanbul as Regional Directorate of Merih Asansör Company. Altes Asansör is involved in domestic sales of Merih Asansör products in Ege and Marmara regions.

Şerifali Mah. Türker Cad. Burhan Sok. No: 27-29 Yukarı Dudullu-Ümraniye/ İSTANBUL
Tel: 0 216 415 67 07



Mars Elevator, 2016 yılında Ankara'da faaliyetine başlamıştır. Komple Asansör Sistemleri satışı, montaj ve bakım hizmetleri vermektedir.

Mars Elevator was founded in Ankara in 2016. The company provides sales, installation, and maintenance services for complete lifts.

Başkent OSB Recep Tayyip Erdoğan Bulvarı No: 5 Malıköy - Sincan/ANKARA
Tel: +90 312 640 15 60 Web: www.marselevator.com

*Merih lifts
your expectations ...*

MERİH®



KLT/EK/04/18.03.2014/08/22.03.2021

MERİH ASANSÖR SAN. TİC. A.Ş.

Başkent OSB R. T. Erdoğan Blv. No : 8 Sincan - Ankara / TÜRKİYE

T : +90.312 640 15 60 pbx • F : +90.312 640 15 67

www.merihasansor.com • info@merihasansor.com



atikasansör

altes
ASANSÖR

MARS